

OPERATING INSTRUCTIONS

Washing machine

EN

WM76M

W7956XLG.AU

W7956XLW.AU

Contents

Introduction	3	Dosing accessories	38
Safety precautions	4	Stains	38
Before using the appliance for the first time	10	Dyeing fabrics	38
Packaging	10	Washing process, step by step (1 – 8)	40
Transport protection	10	STEP 1: Sort the laundry	40
Cleaning	11	STEP 2: Turn on the main switch	40
Opening the Door	11	STEP 3: Open the washing machine door and insert the laundry	40
Installation and connection	12	STEP 4: Add the detergent and the conditioner	41
Selecting the room	12	STEP 5: Choose the program	43
Positioning the washing machine	12	STEP 6: Choosing the program settings	47
Built-in	16	STEP 7: Start the wash	52
Moving the washing machine and transport after installation	17	STEP 8: End of program	53
Connection to water supply	18	Appliance settings	55
Connecting to hot/cold water supply	19	Additional service settings	55
Installing the drain hose	19	Cleaning and maintenance	60
Connecting to the power mains	21	Cleaning the dispenser tray	60
ASKO Laundry Care - Hidden helpers	22	Cleaning the filter	62
Washing machine description	23	Cleaning the appliance exterior	63
Detergent compartment with Auto dose system (ADS)	23	Cleaning the washing machine interior against odours	63
Initial settings before use	24	If you are using hard water	63
Appliance connection with the ConnectLife application	27	Errors: what to do?	64
Special features	30	Manual opening of washing machine door ..	67
Dose	30	Failure display	68
Manual assist	30	Service	72
Auto dose system (ADS)	30	Before calling a service technician	72
Tips before washing	35	Technical information	74
Laundry sorting	35	Typeface License Notice	74
Clothing	35	Information for test institute	75
Laundry symbols	36	Declaration of conformity	77
Laundry types	37	Wi-Fi Network Requirements and Recommendations	77
Reducing allergic reactions	37	Table of consumption values	78
Saving time and energy	37	Option table	80
Economy and efficiency	37	DISPOSAL	81
Detergents	38		

Dear customer,

We thank you for purchasing this quality ASKO product.

We hope it meets all your expectations. Scandinavian design combines pure lines, everyday functionality, and high quality. These are the key characteristics of all our products, and the reason why they are highly appreciated across the globe.

We recommend that you read the user manual before using the washing machine for the first time. The user manual also includes information on how you can help protect the environment.

The following symbols are used throughout the manual and they have the following meanings:

INFORMATION!

Information, advice, tip, or recommendation

WARNING!

Warning – general danger

ELECTRIC SHOCK!

Warning – danger of electric shock

HOT SURFACE!

Warning – danger of hot surface

DANGER OF FIRE!

Warning – Risk of fire / Flammable materials

Original instructions

SAVE THESE INSTRUCTIONS FOR FUTURE REFERENCE!

General



Please read the instruction manual and save it for future reference.

- **Please, do not use the washing machine without reading and understanding these instructions or use first.**
- This appliance is not intended for use by persons (including children) with reduced physical, sensory or mental capabilities, or lack of experience and knowledge, unless they have been given supervision or instruction concerning use of the appliance by a person responsible for their safety.
- **Failure to observe the instructions for use** or inappropriate use of the washing machine may result in damage to the laundry or the appliance, or injury to the user. Keep the instruction manual handy, near the washing machine.
- Instructions for use are available on our website at www.asko.com.
- **This appliance is intended to be used in household and similar applications, such as:**
 - staff kitchen areas in shops, offices and other working environments;
 - farm houses;
 - by clients in hotels, motels and other residential type environments;
 - bed and breakfast type environments.
- **This appliance must not be used in:**
 - areas for communal use in blocks of flats or launderettes.
- Before using the machine, remove all transit bolts. See chapter *Before using the appliance for the first time/ Transport protection*.
- Maximum washing capacity in kg (for the Normal program) is indicated on the rating plate (or in the chapter *STEP 5: Choose the program /Program chart*).

Child safety

WARNING!

Do not let children younger than three years to come near the appliance, unless they are under constant supervision.

Children should be supervised to ensure that they do not play with the appliance.

Keep the detergent and conditioner out of reach of children.

- Before closing the washing machine door and running the program, make sure there is nothing except laundry in the drum (e.g. if a child climbed into the washing machine drum and closed the door from the inside).
- **Activate the Lock (Lock).** See chapter *Appliance settings*.
- **The washing machine is made in compliance with all relevant safety standards.**
- This appliance can be used by children aged from 8 years and above and persons with reduced physical, sensory or mental capabilities or lack of experience and knowledge if they have been given supervision or instruction concerning use of the appliance in a safe way and understand the hazards involved.
- Children shall not play with the appliance.
- Cleaning and user maintenance shall not be made by children without supervision.

Danger of hot surface

HOT SURFACE!

Warning – danger of hot surface

At higher washing temperatures, the door glass will heat up. Be careful to avoid burns. Make sure children do not play near the door glass.

Safety precautions

Connection and installation safety

 WARNING!

The washing machine may only be used with the supplied power cord.

 ELECTRIC SHOCK!

If the **supply cord is damaged**, it must be replaced by the manufacturer, its service agent or similarly qualified persons in order to avoid a hazard.

 WARNING!

Do not connect the washing machine to power mains using an external switching device such as a programme timer, or connect it to power mains that is regularly switched on and off by the power supply provider.

- The appliance has to be connected to the water and power supply by a trained expert.
- Repairs and maintenance must be carried out by a qualified professional.
- **Do not install the washing machine in a room where the temperature can drop to below 5°C**, as washing machine parts may be damaged in case of water freezing.
- The ventilation openings in the base of washing machine must not be obstructed by a carpet.
- After installation, the washing machine should stand still for two hours before it is connected to the power mains.
- The washing machine may not be connected to the power mains using an extension cord.
- Do not connect the washing machine to an electrical outlet intended for an electric shaver or hair dryer.

- To connect the washing machine to water supply, make sure to use the supplied water supply hose and gaskets. Water pressure has to be between 0.1-500 kPa (approximately 1–5 kp/cm², 1-5 bar, 10–50 N/cm²).
- Always use a new water supply hose to connect the washing machine to water supply; do not reuse an old water supply hose.
- The end of the water discharge hose should reach into a water drain line.
- In case of incorrect appliance connection, incorrect use, or servicing by an unauthorized person, the user shall bear the cost of any damage.

Safe use

DANGER OF FIRE!

Do not use detergents that contain solvents as this could lead to release of poisonous gases, damage to the machine, and risk of fire and explosion.

- Only use detergents intended for the washing machine!
- Only use agents for machine washing and care of laundry. We shall not be responsible for any damages or discolouration of gaskets and plastic parts resulting from incorrect use of bleaching or colouring agents.
- Bleaches that contain chlorine can be replaced with oxygen-based bleaches. Otherwise, a neutralization cycle should be performed by running the Normal program at the highest temperature. For best results, use hydrogen peroxide or oxygen-based detergents.
- Do not use colourants (dyes) or bleaching substances (substances for discolouration or removal of colourants) as they contain sulphuric compounds that could cause corrosion.
- Excessive use of products containing chlorine compounds increases the risk of premature failure of appliance components. This depends on the concentration of chlorine, exposure time, and temperature.

Safety precautions

- Before the start of the washing cycle, press the door on the indicated spot until it locks into place. The door cannot be opened during washing machine operation.
- **We recommend removing any impurities from the washing machine drum before the first wash** using the Normal 90°C program (see *Program chart*).
- **After the washing cycle, close the water tap and pull out the washing machine plug from the power socket.**
- Only use the washing machine for washing laundry, as described in the instruction manual. The machine is not intended for dry cleaning.
- No silver ions are released during the washing programme.
- **To remove limescale deposits**, only use agents with added anti-corrosion protection. Follow the manufacturer's instructions. Finish the descaling process by rinsing several times or by starting the Drum Cleaning program to remove any residual acids (e.g. vinegar...).

Overflow guard function

- If the water level in the appliance rises above the normal level, the water level protection will be activated, which will begin to pump out the water and close the water supply.
- If the water level does not decrease in 60 seconds, the program will be interrupted (see chapter *Errors: what to do?*).

Transporting / storage during the winter

If you transport or store the appliance in vehicles or rooms that are not heated and where the temperature could drop to below freezing point, please do the following:

- Clean the drain pump filter. See chapter *Cleaning the filter*.
- Close the water supply to the washing machine, undo the water supply hose from the water supply tap, and wait until the water flows out of the tap and the hose.

- After the drain pump filter is emptied, there can still be a small amount of water in the machine. This, however, does not affect the quality and will not damage the appliance.
- If the washing machine is to be transported, transport protection has to be re-installed (see chapter *Transport protection*).

Before using the appliance for the first time

Packaging

Remove all packaging. When removing the packaging, make sure not to damage the appliance with a sharp object.

Please sort the materials in compliance with local waste management recommendations (see chapter *DISPOSAL*).

Transport protection

Before using the appliance, remove the three transport bolts and plastic plugs which protect the appliance during transport.

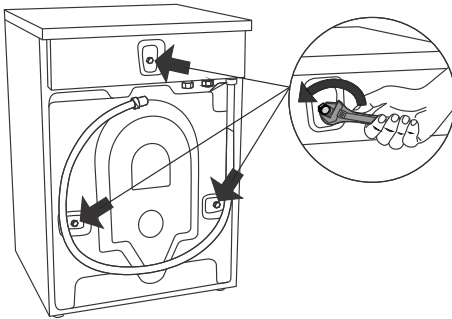

Loosen and use a spanner no. 15 or 17 (depending on the model) to remove the bolts as shown in the figures.

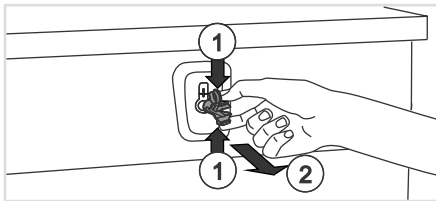

To remove the plastic plugs holding the bolts, squeeze them and (1) then pull them out (2).

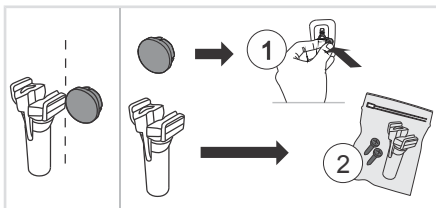

Remove the caps from the plastic plugs. Push the caps into the holes (1), in which the plastic plugs were located. Save the bolts and plastic plugs (2) in case you have to move your washing machine again.

Article number	ID:
270698	Bolt
551188	Plastic cap (transport lock)

Please order three pieces of each item!

Before using the appliance for the first time

💡 INFORMATION!

If you wish to transport the washing machine, reinstall the bolts and plastic caps to lock the machine. This will prevent any damage to the machine due to vibrations during transport. If you have lost the transport bolts or plastic caps, replacements can be ordered at your dealer.

Cleaning

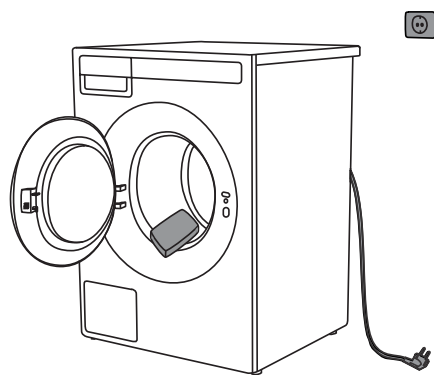

Disconnect the washing machine from the power mains and open the door. Clean the washing machine drum with a damp cloth and a mild detergent.

Connect the washing machine to the power mains, close the washing machine door and run the self cleaning program. See chapter *STEP 5: Choose the program*|*Program chart*

⚠ WARNING!

Do not use any solvents or cleaning agents that could damage the washing machine (please observe the recommendations and warnings provided by the cleaning agent manufacturers).

Opening the Door

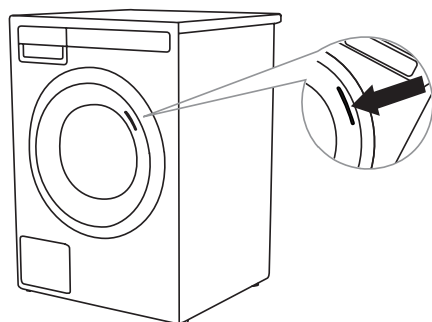

The washing machine door is designed to open on the right side, with a visual indicator in the form of a sticker placed on the front of the door, clearly marking the spot for gripping and opening.

It can be removed depending on aesthetic preference.

Installation and connection

INFORMATION!

Before connecting the washing machine to the power mains, wait for at least 2 hours until it reaches room temperature.

INFORMATION!

The ventilation openings must not be obstructed by a carpet.

Selecting the room

WARNING!

Do not place the washing machine behind lockable or sliding door, or door with a hinge on the opposite side of the door hinge of the washing machine. Place it in the room in such a way that the washing machine door can be freely opened.

INFORMATION!

Floor on which the washing machine is placed must have a concrete base. It should be clean and dry; otherwise, the washing machine may slide. Also, clean the bottom surface of adjustable feet.

INFORMATION!

The washing machine must stand level and stable on a solid base.

Positioning the washing machine

The washing machine can be installed as a built-in or a free-standing unit.

INFORMATION!

When installing the washing machine, the wall outlet should be freely accessible.

Necessary clearance around the washing machine for best performance

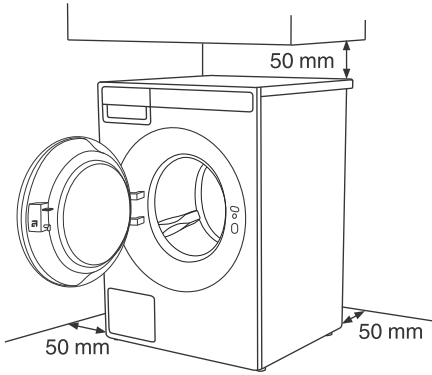

⚠ WARNING!

The washing machine may not be in contact with a wall or adjacent furniture. For optimum washing machine operation, we recommend observing the clearances from the walls as indicated in the figure. In case of failure to observe the minimum required clearances, safe and correct washing machine operation cannot be ensured. Moreover overheating can also occur.

For safety reasons, the minimum distance between the back of the appliance and the wall must be at least 25 mm, and the distance between the appliance and any furniture above it must be at least 40 mm.

Opening the washing machine door (bird's-eye view)

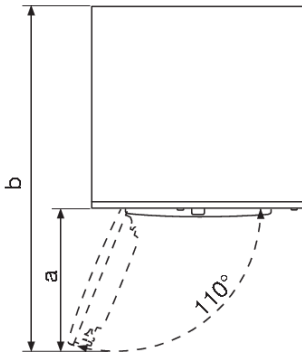

The washing machine door width (a) is 450 mm.

The washing machine depth with the door open (b) is 1055 mm.

The washing machine door can be opened up to the angle of 110°.

Installation and connection

Placement on a pedestal

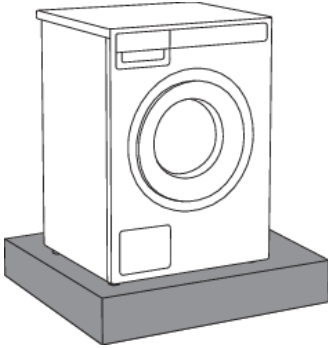

💡 INFORMATION!

If the appliance is installed on a plinth or a similar structure, then the appliance must be fixed to it, to avoid the risk of falling. ASKO original accessories are available for this purpose, complete with fixing instructions.

Adjusting the washing machine feet

Place the washing machine so that it is stable. This will reduce washing machine noise, vibration, movement etc. to minimum.

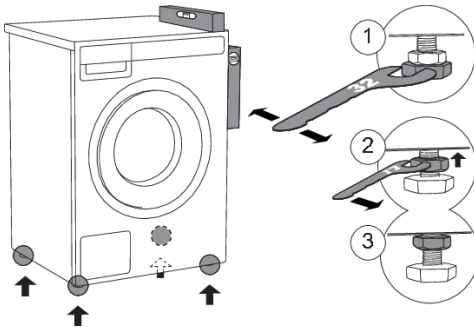

1 Level the washing machine in all directions and traverse direction by rotating the adjustable feet (using a spanner no.32).

The feet allow levelling by +/- 1 cm.

2 When the appropriate height of feet is set, use a spanner no.17 to firmly tighten the lock nuts (counter nuts) towards the bottom of the machine ↑.

3 Tighten the jam nuts (counter nuts) to the end position.

💡 INFORMATION!

Incorrect levelling of the washing machine with the adjustable legs may cause vibration, appliance sliding across the room, and loud operation. Incorrect levelling of the washing machine is not subject to warranty.

💡 INFORMATION!

Sometimes, unusual or louder noise may appear during appliance operation; these are mostly the result of improper installation.

Free-standing appliance

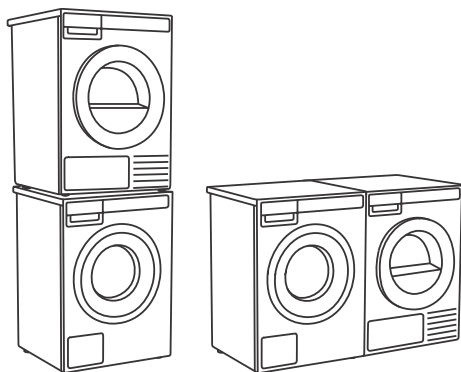

The surface on which the appliance is placed should be clean and level.

The washing machine and the dryer can be placed next to each other.

To stack a dryer on top of a washing machine, use the front feet attachments and the tipping guard. See the next section below.

Stacking an ASKO dryer on top of an ASKO washing machine

⚠ WARNING!

At least two persons are required to install the tumble dryer on top of a washing machine.

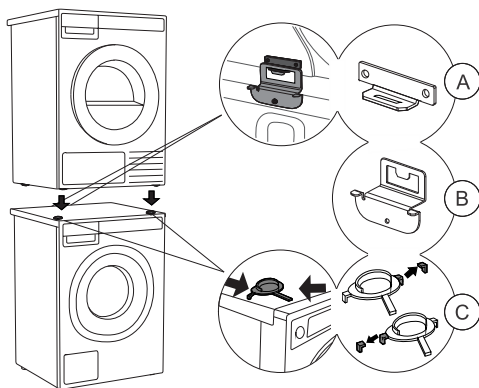

To stack a dryer on top of a washing machine, use the front feet attachments (plastic footrests (C)) and the tipping guard (A+B), supplied in the dryer drum.

If the washing machine and dryer are not of the same dimensions, or if you have installed an intermediate compartment between the washing machine and dryer Hidden Helper, you can purchase a connecting plate intended for the WM86-TD76 combination from your dealer or at the repair shop.

💡 INFORMATION!

For detailed instructions on how to install the ASKO tumble dryer on the ASKO washing machine, refer to the instructions provided with your ASKO tumble dryer.

💡 INFORMATION!

The tipping guard (A+B) corresponds to ASKO washing machines and cannot be installed on washing machines of other brands.

Installation and connection

💡 INFORMATION!

Washing machine on which you wish to install the dryer must be able to bear the weight of the dryer (see washing machine's rating plate or technical information).

All ASKO washing machines will bear the weight of the dryer.

Built-in

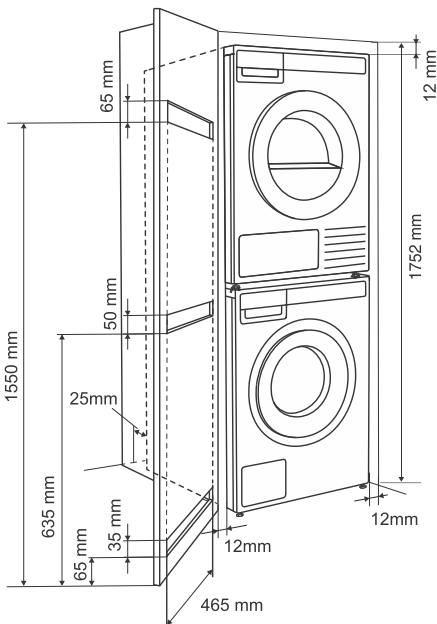

Installation in a cabinet

ASKO's front panel controls make it possible to install the washers and dryers in a cabinet or closet.

Between the machine and the cabinet or wall, ensure that there is a minimum distance of 12 mm and a minimum distance of 25 mm between the rear edge of the top panel of the machine and the cabinet or wall. To ensure proper ventilation, a door with grilles is recommended. Otherwise, there must be ventilation openings in the door. See figure for the smallest feasible ventilation openings.

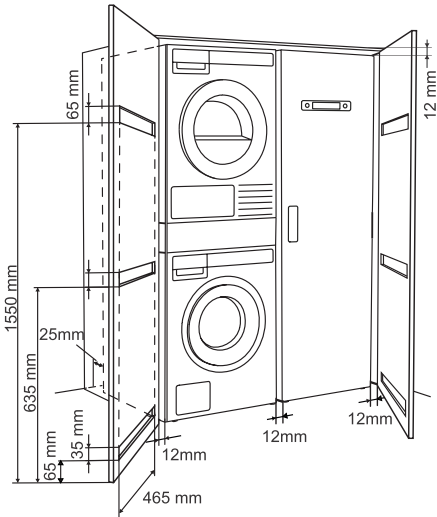

Ventilation Requirements of ASKO laundry concept or closet installation

Make sure there is clearance between appliances and cabinet or wall and 25 mm minimum clearance between the rear edge of the appliance top panel and the cabinet or wall.

When closet or cabinet is closed by the door, we recommend louvered doors, to ensure proper ventilation.

Otherwise, the door must be fitted with ventilation gaps. See figure for dimensions of ventilation openings.

💡 INFORMATION!

Ensure that the washing machine door can be opened without hindrance after installation.

⚠ WARNING!

Disregarding of instructions influences on appliance performance and may also result in failure of the appliance.

Moving the washing machine and transport after installation

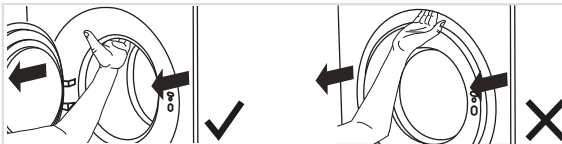

If you are moving the washing machine without packaging, open the washing machine door and pull the appliance by holding the washing assembly, as indicated in the figure.

💡 INFORMATION!

For any further moving of the appliance, use the transport protection (the washing machine drum has to be blocked). See chapter *Transport protection*.

Installation and connection

Connection to water supply

💡 INFORMATION!

The water inlet hose is included inside the drum of the washing machine. Before use, it must be connected to the appliance and the water supply.

💡 INFORMATION!

The machine has to be connected to water supply by an adequately trained person.

AQUA - STOP

If an internal tube or hose is damaged, a shut-off system is activated that cuts the water supply to the washing machine. In such case, the control glass (a) will turn red. Replace the water supply hose.

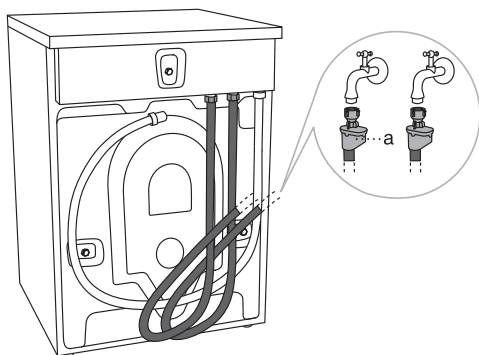

Use the water supply hose to connect the appliance. Water pressure has to be between 0.1-500 kPa (approximately 1–5 kp/cm², 1-5 bar, 10–50 N/cm²).

If the hoses are newly installed, we recommend rinsing them to remove any impurities. Otherwise, these impurities could clog the filter in the water connection on the washing machine and thus cut off the water supply.

The water intake hose has to be fastened firmly enough for the hose to have a good seal. After connecting the hose, the seal must be checked for any leaks.

💡 INFORMATION!

The washing machine has a sensor that detects water leakage. If there is water on the bottom of the washing machine, the sensor is activated and trigger a shut-off system to cut the water supply to the washing machine; washing process is stopped, water supply is shut off, the appliance engages the pump, and signals an error.

💡 INFORMATION!

Only use the water supply hose supplied with the appliance. Do not use any used or other hoses.

💡 INFORMATION!

If the connection on the supply hose is of different dimensions than the water tap (e.g. 3/4" → 1/2"), use an adapter.

INFORMATION!

When connecting the water supply hose, make sure to connect it in a way that allows adequate and unobstructed water supply.

Connecting to hot/cold water supply

Your washing machine has a hot and cold water connection. Connect one hose to the cold water connection and the other hose to the hot water connection, as indicated on the back of the appliance:

COLD = cold and

HOT = hot.

Hot water is supplied for programs operating at 40 °C or more.

WARNING!

The hot water temperature must not exceed 70 °C (60 °C in the UK (United Kingdom)).

INFORMATION!

Connecting to both hot and cold water will save time and electric energy when washing.

If your washing machine model has connections for both hot and cold water, and you only wish to connect cold water, the protective cap must remain in place on the hot water inlet. The appliance will function normally in any configuration – no additional settings are required.

Installing the drain hose

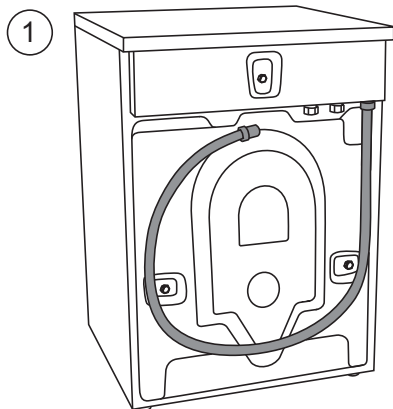

Upon delivery, the washing machine has a drain hose attached to the back wall (Figure 1), which must be connected to the drain.

INFORMATION!

If the drain hose is not correctly attached, safe and correct washing machine operation cannot be ensured.

Installation and connection

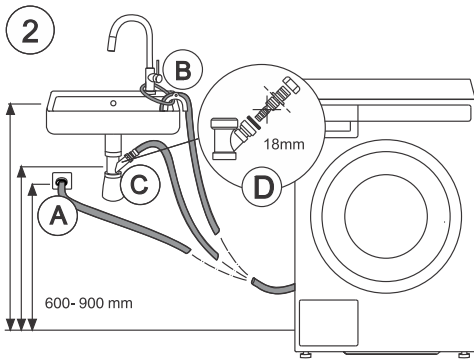

The drain hose can be installed in three ways (see Figure 2):

- 1 Into a wall drain with a siphon (A), which must be properly installed so that it can be cleaned;
- 2 Into a sink or bathtub (B). Use a string to attach the hose through the opening in the elbow so that it does not slip to the floor;
- 3 Directly into the sink drain (C). The diameter of the drain hose must be at least 4 cm. The internal hose diameter should be at least 18 mm (D).

The end of the drain hose can be no more than 900 mm and at least 600 mm from the ground. The lower position (60 cm) is always recommended. Make sure the drain hose is not bent.

Connecting to the power mains

ELECTRIC SHOCK!

After installation, the washing machine should stand still for two hours before it is connected to the power mains.

Connect the appliance to an earthed power outlet. After installation, the wall outlet should be freely accessible. The outlet should be fitted with an earth contact (in compliance with the relevant regulations).

Connection upon delivery

Information about your washing machine is indicated on the rating (type) plate.

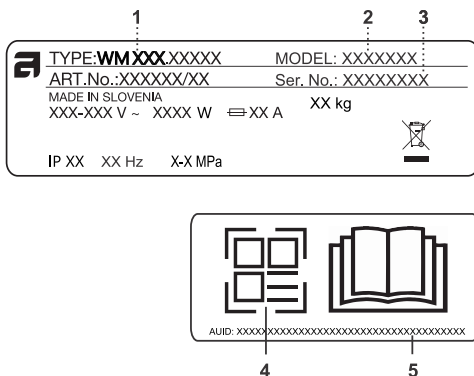

①

- 1 - Model type
- 2 - Model
- 3 - Serial number

②

- 4 - QR code
- 5 - AUDID code

Use the type A differential current protection switch.

ELECTRIC SHOCK!

We recommend using overvoltage protection (overvoltage protection) to protect the appliance in case of a lightning strike.

WARNING!

The washing machine may not be connected to the power mains using an extension cord.

INFORMATION!

Do not connect the washing machine to an electrical outlet intended for an electric shaver or hair dryer.

INFORMATION!

Repairs and maintenance must be carried out by a qualified professional.

Installation and connection

ASKO Laundry Care - Hidden helpers

The Hidden Helper (single shelf, basket, or ironing board) can be installed between the washing machine and the dryer, or on top of either appliance.

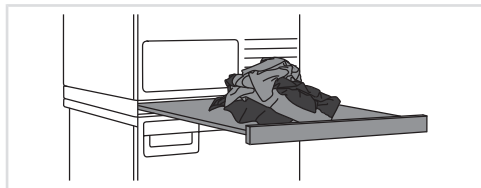

SLIM - Single Shelf

Pull-out shelf. It can be used as an additional surface when folding clothes and sorting socks or for storage. It also makes loading and unloading your laundry much easier. It can be installed between your washer and dryer.



BASKET

A large pull-out basket that is easily accessible via a push-pull door opening. Useful for removing laundry and carrying it to the wardrobe or workbench for ironing and folding.

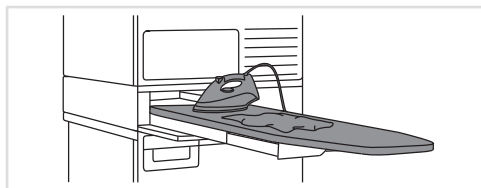

IRONING BOARD

The ironing board is a clever solution. It is always handy when you need to iron your clothes, and it can be easily, safely and invisibly stored away when not in use.

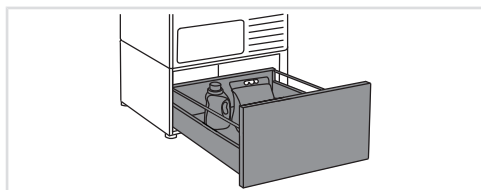

A PEDESTAL DRAWER

A useful storage drawer with a height of 30 cm. Ideal for storing your detergent, softener, coat hangers, pegs, user manuals and other useful items in the laundry area.

The pedestal drawer is installed under the washing machine or the dryer.

Availability depending on market

DENOMINATION	White ART. No.	Titanium ART. No.	Graphite black ART. No.
SLIM	HS60W - 746295	HS60T - 746296	HS60G - 746297
BASKET	HB150W - 746298	HB150T - 746299	HB150G - 746300
IRONING BOARD	HI150W - 746311	HI150T - 746312	HI150G - 746314
A PEDESTAL DRAWER	HP320W - 746315	HP320T - 746316	HP320G - 746317

Washing machine description

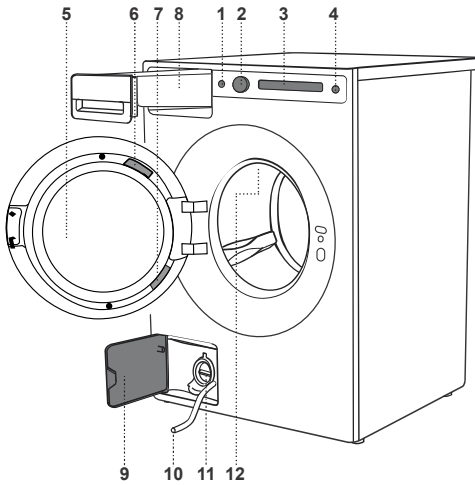

1. Main switch for turning On/Off
2. Knob for selection and confirmation
3. Touch screen
4. Start/Pause button
5. Washing machine door
6. QR and AUID code (on the perimeter of the washing machine door)
7. Rating plate with information about the washing machine (on the inside of the washing machine door)
8. Dispenser tray
9. Drain filter cover
10. Water release hose
11. Drain filter pump (installed behind the drain pump filter)
12. Drum illumination

Detergent compartment with Auto dose system (ADS)

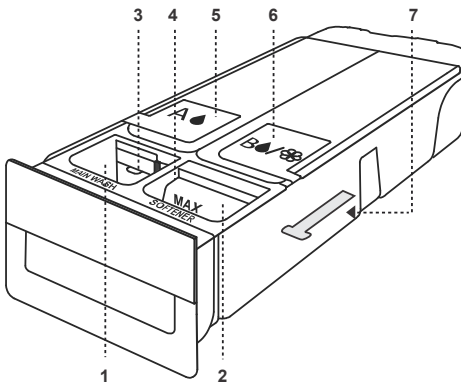

1. Compartment for main wash liquid and powder detergent with the inscription »MainWash«
2. Softener compartment with the inscription »Softener«
3. Separator or movable barrier (3)
Use the upper position for washing powder. Use the lower position for liquid detergent.
4. Level gauge
The level gauge, which shows »ml« on one side and »tbsp« on the other. Pull it upwards and flip it to the other side.
5. Tank (A) for liquid detergent for ADS
6. Tank (B) for liquid detergent or softener for ADS
7. Release mechanism for the detergent compartment (on the bottom side)

Initial settings before use

When the appliance is connected and switched on for the first time (see chapter *Installation and connection*), first select the language.



Scroll left or right to navigate the list of languages then press the desired language to confirm your selection.

WARNING!

After the language has been selected, the appliance informs you that it is necessary to remove all transport protection from the washing machine. If you have already done so, continue setting up the appliance by pressing Confirm.

Now it is necessary to set the appliance to your settings. Touch OK to continue.

You can select the following settings in the next step:

Water hardness



Choose between the following water hardness settings: Soft / Medium - Normal /Hard .

For more information, press  *Information*.

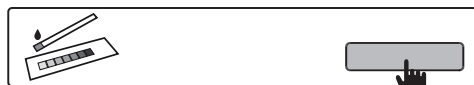

How to determine the hardness of the water:

- use the test strip,
- contact your local water distributor.

How to use the test strip:

1. Turn on the water tap and let the water run for a minute or so.
2. Fill a glass with cold water.
3. Remove the test strip from its packaging.
4. Dip the test strip in the water for about one second.
5. Wait one minute. Now compare the colours of the squares with the water hardness table.

Table for water hardness; see chapter *Appliance settings/ Water hardness* .

The amount of detergent also depends on the hardness of water. For details, see the detergent packaging. Please contact your local water supply company to check the water hardness in your area.

INFORMATION!

Before the product is dispatched from the factory, every appliance is tested.

As a result, there may be some residual water left in the discharge pump filter. This, however, does not affect the quality and will not damage the appliance.

Initial settings before use

Temperature unit



Set the unit of measurement for temperature:

- Celsius **°C** or
- Fahrenheit **°F**.

Liquid unit



Set the unit of measurement for liquids:

- Millilitres **ml** or
- Tablespoons **tbsp**.

Weight unit

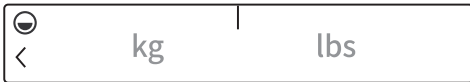

Set the unit of measurement for weight:

- Kilogrammes **kg** or
- Pounds **lbs**.

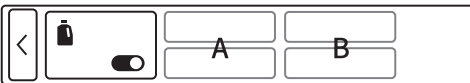

Auto dose system



Choose between **turning on**  or **turning off**  the ADS.

With this setting, you will choose which tank (A or B) the detergent will be dispensed from.

A  Liquid detergent for: coloured, white, black, delicate or other laundry.

B   Liquid detergent for: coloured, white, black or delicate laundry, softener or other rinse aids.

Do not pour detergents with bleach into tank B. Choose the amount of detergent according to the liquid detergent manufacturer's recommendations on the packaging.

INFORMATION!

In models with ADS the amount of detergent dispensed also depends on the water hardness setting.

For detailed ADS menu settings, see chapter *Special features*.

Wi-Fi settings

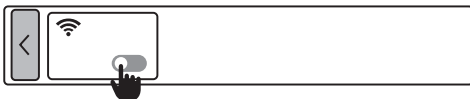

Choose between **turning on**  or **turning off**  the Wi-Fi connection.

If you have turned on the Wi-Fi connection, see setup procedure in the below chapter *How to enable Wi-Fi on the device?*.

Initial settings before use

To cancel the procedure of connecting to Wi-Fi, do so by pressing .

Automatic extra rinsing



Automatic addition of rinsing according to the degree of soiling. When switched on, the sensor itself detects and adjusts the number of additional rinses.



By pressing the last OK button, you confirm and complete the settings before first use.

Your washing machine is now set up and ready to use.

Appliance connection with the ConnectLife application

ConnectLife is an advanced smart home platform that enables seamless connectivity between people, devices, and services. With the ConnectLife app you can easily monitor and manage your smart devices, receive notifications directly to your smart device and update software (available functions depend on your appliance and region).

To connect your smart device to the ConnectLife platform, you need a home Wi-Fi network (2.4 GHz networks are supported) and a smart device with the app ConnectLife.



STEP 1: Download the ConnectLife app by scanning the included QR code or searching for it in your favorite app store.

STEP 2: Install the ConnectLife app and create an account.

STEP 3: In the ConnectLife app, go to the »Add device« menu and select the appropriate type of device. Then scan the QR code (it can be found on the rating plate of the appliance; you can also enter the AUID/SN number manually).

STEP 4: The application then guides you through the entire process of connecting the appliance to your smart device.

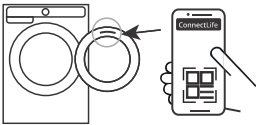

After a successful connection, the appliance can be operated remotely via the application.

Useful tips for your smart device

INFORMATION!

The QR code of the device required by the app during the installation process can be found on the rating plate of the appliance (see chapter: *Service*).

How to enable Wi-Fi on the device?

1. Turn on the appliance. In the main menu, go to the far left and select *Additional service settings*.
2. Select *Wi-Fi settings*.
3. Make sure that the *Wi-Fi* setting is switched on (On) .
4. Select *Connection setup*.

If you do not yet have the ConnectLife app installed on your smartphone (or any other smart device), install it now (scan the QR code on the screen), create your user account and login.

- In the ConnectLife app, open the add device menu.
- Follow the instructions in ConnectLife.
 - Select the type of appliance.
 - Scan the QR code (it can be found on the rating plate of the appliance).
- On the appliance, press *Next* twice.
 - The 5 minute countdown will begin. During this time, connect the app to the appliance.
- In the ConnectLife app, instructions will guide you through the process of entering the appropriate data for your appliance to connect to your home network.

Initial settings before use

How to enable remote start of the appliance?

In the main menu, select *Remote start*. To activate, press the Start/Pause button (the door must be closed) and confirm settings with press »*Confirm*« on the screen. It is displayed (*Remote start/Activated*).

The appliance is now ready for remote control through ConnectLife app.

INFORMATION!

Remote start will remain active for the next 24 hours unless cancelled. During this time, the appliance can enter standby mode and switch off the display. If this happens, the logo will remain lit, which means that *Remote start* is still active.

How to add another user or multiple users?

See chapter *How to enable Wi-Fi on the device?* and observe points 1 and 2.

Select *Add device (Pair device)*. As a new user, if you do not yet have the ConnectLife app installed, install it on a smart device.

- In the ConnectLife app, go to the Add device menu and follow the instructions.
- On the appliance, press *Next*.
 - The 3 minute countdown will begin. During this time, connect the app to the appliance.
- You can then complete and confirm the setting in the app.

How to remove the users?

How to remove a user (Unpair device)?

See chapter *How to enable Wi-Fi on the device?* and observe points 1 and 2.

Select *Unpair device*. Press *Ok*.

INFORMATION!

This step will remove all active users of the appliance. If you want to operate the appliance remotely again you will need to repeat the process of adding a user.

Which Wi-Fi router can be used?

Only 2,4 GHz networks are supported. If the ConnectLife app cannot find your local network during the connection set-up process, check the following:

- your router is operating at the frequency of 2.4 GHz,
- your network is hidden, and
- your signal is strong enough.

Do you have more questions?

Please visit us at www.connectlife.io or contact us at hello@connectlife.io.

Remotely upgrading the software

When you receive a software update notification, you can choose to update your software from the app menu in your settings. Upon confirmation, the update is performed, the appliance must be in standby mode during this time (more on standby mode in chapter *Table of consumption values*).

Check the software update options in the ConnectLife app.



Special features

Dose



To enter the dose modes settings (Dose) first select the desired washing program and press on the third icon indicating.

Choose between:

- Assistance with manual detergent dosing if you select **Manual Assist** by pressing **On** .
- Dosing of detergent from tanks A or B, if you have previously selected **On**  **ADS** (see next chapter *Auto dose system (ADS)*).
- **Choose dirt level** (you can choose between 3 levels).
- If none of the options is selected, the washing machine will automatically pump the dispensed detergent from the manual dosing chamber.
- The contents of reservoirs A and B do not affect the other compartments in the detergent dispenser compartment.

Manual assist



By **turning on**  manual assist, the washing machine will recommend the optimum amount of detergent according to the selected settings.

When you select the washing program and press **Start/Pause**, the manual detergent dosing program will offer the amount of detergent (left: concentrated /right: unconcentrated amount of liquid detergent).

Dose the recommended amount into the dosing container and press **Start/Pause**.

Assistance with manual detergent dosing must be selected each time the washing program is started. In some programs the function is not available.

Auto dose system (ADS)

1. Choosing the settings for ADS
2. Filling the tank for ADS
3. Switching off the auto dose in the ADS menu.

1. Choosing the settings for ADS

The auto dose system (Auto Dose System) (hereinafter referred to as ADS) allows you to store and dispense softener and liquid detergent in separate reservoirs located in the dispensing tank, in addition to the manual detergent dispenser compartment.

When the ADS function is enabled, the appliance will automatically dispense the detergent and softener.

The ADS settings can be accessed via the Program settings. Select the desired program and select the Dose modes setting.

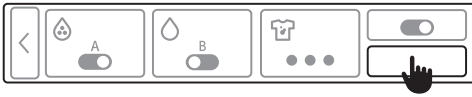

In the dose modes menu (Dose) enter Settings.

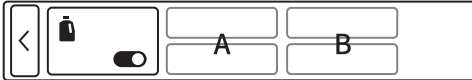

Turn on ADS. With this setting, you will determine which detergent will be dispensed from tank A and which from tank B.

The most recent setting is stored and it can be changed for the next washing cycle. In some programs the ADS setting is not available.

A, B. Choose the tank from which the detergent will be dispensed, depending on the type of laundry.

Type of laundry:

A Liquid detergent for: coloured, white, black, delicate or other laundry.

B Liquid detergent for different types of laundry, softener or other rinse aids.

WARNING!

If tank B is set to liquid detergent for coloured, white, black or delicate laundry, only one tank for ADS can be switched on at a time.

In the event that tank B is set to softener or other detergents, tanks A and B can be activated at the same time.

WARNING!

When there is a shortage of detergent in tank A or B, refill notifications and symbols will appear.

Follow the instructions on the screen.

When selecting the Wool/Hand wash program use wool detergent and avoid using fabric softener.

By pressing back you return to the dose modes menu.



You can choose between: automatic detergent dosing from tank A or from tank B. Confirm the selection by **turning on** .

Before choosing tank A or B, you must fill the tank with liquid detergent.

Special features

C. Choose laundry dirt level. Choose between:

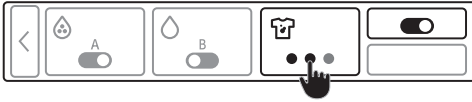

- Lightly soiled laundry
- Normally soiled laundry
- Heavily soiled laundry

The washing program will choose the suitable amount of detergent depending on the setting for dirt level you choose.

Return to ADS settings

a, b. Amount (Concentration) of liquid detergent (ml/cycle from tank A or B).

Choose the amount of detergent according to the liquid detergent manufacturer's recommendations on the packaging.

For both tanks, you can specify the amount of agent to be dosed from 10 ml to 100 ml.

For this washing machine model, observe the recommendation for a load of 4-6 kg, medium water hardness, and medium-soiled laundry.

The amount of detergent or softener dosed will be adjusted for:

- **Water hardness** (available degrees are: soft, medium - normal and hard. The basic/preset degree is medium, which can be changed by the user. For correct functioning of the ADS system, we recommend setting the correct water hardness level (see chapter *Appliance settings/ Water hardness*).
- **Selected washing programme.**
- **Amount of laundry (load).**
- **Set dirt levels.**
- **Set value of liquid detergent.**

c. Changing the liquid detergent in the ADS

We recommend changing the detergent when the tank is empty. Otherwise the tank must be emptied and cleaned (See chapter *Cleaning the dosing container*).

When you change the detergent in the tank B, select the appropriate washing program based on the type of laundry.

In the case of the following combinations:

- White laundry program + white laundry detergent + off ADS or
- Program for coloured laundry + coloured laundry detergent (but not selected)

then, pour a different type of liquid detergent into tank B than the one selected in tank A. For example, if you have chosen the Black program, you will likely pour a detergent specifically designed for black laundry into the tank. For certain programs, you will be notified to select the appropriate detergent.

INFORMATION!

If the tank is not empty, the dosing container must be removed and the tank cleaned (see chapter *Cleaning the dispenser tray*).

2. Filling the compartment with liquid detergent

When you want to use the ADS function for the first time, you will need to fill the dosing container.

⚠ WARNING!

While the washing program is running, do not open the dosing container and do not add softener or liquid detergent to the ADS compartment.

💡 INFORMATION!

Start dispensing the liquid detergent into the selected tank. The tank can be filled to the MAX mark (maximum amount of detergent that can be poured into the tank is 1.1 l).

DESCRIPTION OF THE DOSING CONTAINER

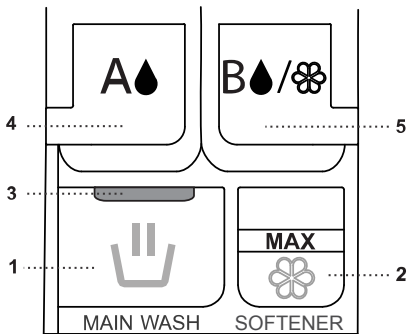

- 1** - Compartment for main wash liquid and powder detergent with the inscription »MainWash«.
- 2** - Compartment for softeners with the inscription »Softener«.
- 3** - Separator or movable barrier.
- 4** - Tank (A) for liquid detergent for ADS.
- 5** - Tank (B) for liquid detergent or softener for ADS.

FILLING PROCESS

- 1** - Pull out the dosing container.
- 2** - Open the lid of the ADS tank A and pour liquid detergent into it up to the mark »MAX«.
- 3** - Open the lid of the ADS tank B and pour liquid detergent, softener or other detergent up to the mark »MAX«.
- 4** - For washing without ADS, pour liquid or powder detergent into the front left compartment with the inscription »MainWash«.
- 5** - Pour the softener into the front right compartment for washing without ADS.
- 6** - Close the detergent container.

⚠ WARNING!

Do not place any powder detergent in the ADS compartment.

Special features

- If the ADS system is activated, you can also add fabric softener or other liquid detergents (e.g. stain remover) to the dispenser.
- At the beginning of the programme, water will flow through the dispenser and collect all added agents, even if the ADS system is active.
- The contents of the dispenser will be used – therefore, do not add any agents that are not required.
- Improper use of additional detergents in the dispenser may cause excessive foaming in the machine.

💡 INFORMATION!

Only use liquid detergents and softeners or gels recommended by the manufacturer for use in Auto dose.

Do not mix different liquid detergents or softeners. If you are changing the liquid detergent (type, manufacturer...), empty the dosing container completely and clean the dosing container compartments (see chapter *Cleaning and maintenance*/Cleaning the dispenser tray).

Do not mix detergent and softener.

Do not use concentrated or strongly concentrated detergents or softeners (maximum permissible viscosity is 800 mPa.s). You can only use them if you dilute them with water.

To prevent the dosing container from drying out, do not leave the dosing container lid open for long periods of time.

We recommend pouring liquid detergent or softener only up to the MAX marking in the compartments.

⚠️ WARNING!

Do not use any solvent-based, corrosive or gas-emitting products (e.g. liquid bleach).

3. Switching off auto dose in the ADS menu.

In the dose modes menu (Dose) enter Settings ADS.

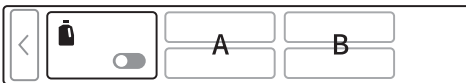

Switch off ADS. Thus, the system will not automatically dose the detergent.

💡 INFORMATION!

Prewash cannot be selected if ADS is switched off.

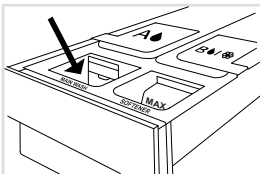

When using a washing program with ADS switched off or disabled, add detergent to the manual detergent compartment.

Fill the compartment with liquid or powder detergent. Follow the markings on the separator/movable partition for powder/liquid detergent. When using powder detergent, lift the separator or movable partition upwards.

This chapter includes several tips on how to prepare the laundry for washing.

Before using the washing machine, carefully remove any solid objects and particles from the textiles you intend to wash to prevent damage to the appliance or clogging of the pump filter. This includes (also check all pockets and flaps):

- solid objects (e.g., screws, clips, small stones, hay, etc.),
- food residues (e.g., bones, dried dough, etc.),
- dried particles of construction materials (e.g., mortar, sand, mud, etc.).

WARNING!

The manufacturer assumes no responsibility for malfunctions resulting from failure to follow these instructions, which may also affect the validity of the warranty. Furthermore, the manufacturer does not cover service costs in the event of foreign objects in the pump or pump cleaning.

Laundry sorting

Sort the laundry according to:

- how soiled it is,
- colour,
- material,
- permissible washing temperature.

Clothing

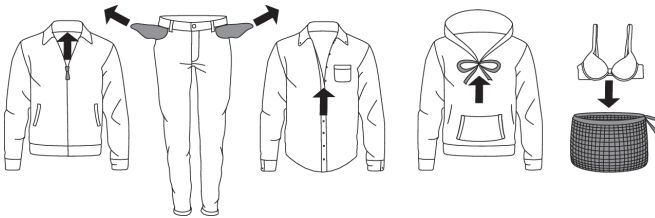

- Sort the laundry by type of fabric, colour, soiling, and allowed washing temperature (see *Program chart*).
- Wash the laundry that sheds a lot of fibre or lint separately from other laundry.
- Empty the pockets. Coins, nails etc. could damage the machine and the fabric.
- Close the buttons and zippers, tie any ribbons, and turn the pockets inside out; remove any metal clips that could damage the laundry and washing machine interior, or clog the drain.
- Turn delicate items inside out. This will decrease the risk of tear and colour fading.
- Place very sensitive clothes and small items in a special-purpose laundry washing bag. (The special-purpose laundry bag is available as an optional accessory.)

Tips before washing







Laundry symbols

Observe the laundry symbols.

Textile maintenance symbols:

Normal wash;





Sensitive laundry

	Max. washing temp. cold - 90°C		Max. washing temp. 40°C		Hand wash only
	Max. washing temp. 60°C		Max. washing temp. 30°C		Do not wash





Bleaching

	Bleaching in cool water		Bleaching not allowed
---	-------------------------	---	-----------------------







Dry cleaning

	Dry cleaning with all agents		Perchloroethylene R11, R113, petroleum
	Dry cleaning in kerosene, pure alcohol, and R113		Dry cleaning not allowed

Ironing

	Hot ironing, max. 200°C		Hot ironing, max. 110°C
	Hot ironing, max. 150°C		Ironing not allowed

Drying

Natural drying		Tumble drying	
	Drying on a flat surface		Drying at high temperatures
	Drying without prior spinning		Drying at low temperatures
	Drying on a clothes line or a hanger		Tumble drying not allowed

Laundry types

Dyed cotton

Laundry made of dyed cotton which is to be washed at 40 °C should be first washed at a temperature of 60 °C to remove the excess dye. If this is not done, there is danger of dye being washed out of such items. To maintain the colour of the fabric, use bleach-free detergent.

Unbleached linen

Unbleached linen fabrics should be washed at 60 °C with a detergent free of bleach or optical bleaching agents. Heavily soiled linen laundry may be occasionally washed at higher temperatures, but do not do this too often as heat could ruin the shine and strength of linen laundry.

Wool

These fabrics are intended for either machine or hand wash. The Wool/Hand Wash program is equally gentle or even gentler than an actual hand wash.

Wool in particular is sensitive to washing and similar procedures.

When selecting the Wool/Hand wash program use wool detergent and avoid using fabric softener.

If you do not wish to spin your clothes, select a setting without spinning (see chapter *STEP 6: Choosing the program settings*). However, most clothes are able to withstand a short spinning period. Top spinning speed available is 800 rpm.

Viscose and synthetic fibres

Materials made of viscose and some synthetic fibres are highly sensitive, and require a lot of space in order not to crease. When washing fill the recommended load for the program and choose a program with spinning speed of no more than 1200 rpm.

INFORMATION!

Viscose and acetates are fragile when wet.

Reducing allergic reactions

Possibility of washing with the Anti-Allergy Synthetics program. This program, program settings, and features should be used for people with sensitive skin, such as those suffering from allergies, or small children. We recommend turning the garments inside out as this will also thoroughly wash out the skin residues.

Saving time and energy

Save time by using Speed mode and save power with the Eco (ecological) washing mode (Green mode).

Economy and efficiency

You can save a lot of energy by not using the programs operating at higher temperatures.

Select the Quick program if you wish to only refresh the laundry or use the Time program. This will save water and power.

Tips before washing

Selecting the maximum spinning speed will reduce power consumption if you dry the clothes in a dryer or a drying cabinet.

Detergents

INFORMATION!

Detergents carrying the environment protection label are less harmful to the environment.

Only use detergents for machine washing.

When using thick liquid laundry care products, we recommend diluting them with water to prevent clogging the dispenser tray drain.

Liquid detergents are intended for washing programmes without a prewash cycle.

Only add the detergents in compliance with the recommendations by detergent manufacturers. Recommended amount of washing detergent at certain loads and water hardness levels are specified on the detergent packaging.

Dosing accessories

To correctly dose detergents, especially liquid ones, use the accessories provided by the detergent manufacturer.

Stains

If your clothes are soiled with stubborn stains (blood, eggs, coffee, grass etc.), they should be appropriately treated before the wash. Then, wash your laundry using the special programs (if your washing machine has them).

Before using special-purpose stain removers, try using the natural methods that do not harm the environment on less stubborn stains.

However, prompt action is required! Soak the stain with an absorbent sponge or a paper towel; then, rinse with cold (lukewarm) water – but never with hot water!

When using bleaches or stain removal agents, there is danger of rust (corrosion) and discolouration.

WARNING!

To protect the environment, we advise against using powerful chemicals.

Do not use any chemical substances or agents; only use the stain removing detergents.

Dyeing fabrics

If you want to dye fabrics in the machine, choose the Normal program with the option to select the Super rinse function. Choose the temperature according to the dye manufacturer's recommendations. If you dye mixed fabrics, such as polyester/cotton, choose a low spinning speed.

After dyeing use the Drum Cleaning program. Use the usual amount of detergent.

When using bleaches or stain removal agents, there is danger of rust (corrosion) and discolouration.

WARNING!

To protect the environment, we advise against using powerful chemicals.

If you wash at low temperatures and/or with liquid detergents, there is a risk of developing microorganisms and an unpleasant odour in the washing machine. Leave the washing machine door open after each wash to allow the appliance to dry. If you detect an unpleasant odour, run the Drum Cleaning programme.

To prevent and remove limescale deposits only use agents with added anti-corrosion protection. Observe the cleaning agent manufacturer's instructions. To remove limescale deposits, we recommend starting the Drum Cleaning programme. Add spirit vinegar (2 dl).

We recommend avoiding washing very small amounts of laundry as this will lead to excessive use of energy and poorer washing machine performance.

You can save energy and water by filling up the washing machine to the capacity specified by the manufacturer for each programme.

Washing process, step by step (1 – 8)

STEP 1: Sort the laundry

See chapter *Tips before washing*.

⚡ INFORMATION!

Use a washing net for underwire bras. Empty the pockets. Coins, nails etc. could damage the machine and the fabric.

STEP 2: Turn on the main switch

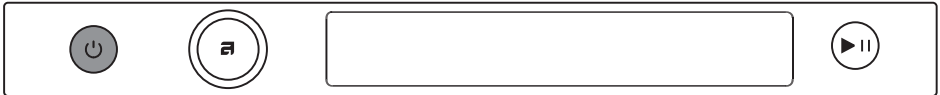

On/Off

Press the  on/off button.

STEP 3: Open the washing machine door and insert the laundry

Open the washing machine door by pulling the handle towards you.

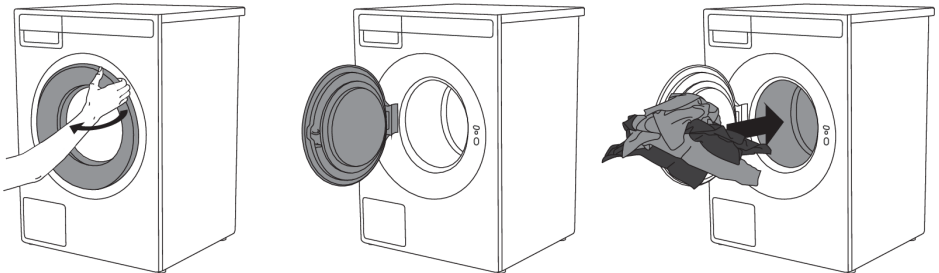

Place the laundry into the washing machine drum.

Before doing so, make sure the drum is empty.

Do not overload the drum!

If the washing machine drum is too full, the laundry will not be washed as thoroughly.

⚡ INFORMATION!

The washing machine drum is also lit for 5 minutes when the washing machine is switched on. The lamp in the washing machine drum is not suitable for any other use. The lamp in the washing machine drum may only be replaced by the manufacturer, a service technician or an authorised person.

Washing process, step by step (1 – 8)

STEP 4: Add the detergent and the conditioner

Recommended amount of detergent is usually specified on the detergent packaging. When washing a smaller amount of laundry, the amount of detergent used can be decreased.

Observe manufacturers' recommendations regarding the type of detergent suitable for certain temperatures, load size, and water hardness.

When using ADS, the appliance will automatically add the liquid detergent and the softener depending on the amount of laundry and the other settings.

Powder detergent

Only dispense the powder detergent into the front main wash/hand wash compartment »MainWash«. Do not put any powder detergent in the container for ADS.

INFORMATION!

We recommend adding the powder detergent immediately before the washing cycle. Otherwise, make sure the detergent compartment is completely dry before adding the powder detergent, as otherwise, the powder detergent may cake before the start of the washing process.

Liquid detergent

When using liquid detergent and softeners, follow the detergent manufacturer's recommendations. When using thick detergents, we always recommend using the laundry balls. In the detergent compartment, use the separator (3); see figure in the chapter Description of the washing machine *Washing machine description Detergent compartment with Auto dose system (ADS)*.

Add the liquid detergent to the Main wash dispenser (1) or into the tank A or B for ADS.

Liquid detergent in ADS

The washing machine will automatically add the amount of liquid detergent and softener depending on the amount of your laundry and how heavily soiled it is.

Compartment (A) for liquid detergent for: coloured, white, black, delicate or other laundry.

Compartment (B) for liquid detergent for different types of laundry, softener or other rinse aids.

See chapter: *Special features*.

In case of excessive foaming, check the water hardness settings (see chapter *Appliance settings/ Water hardness*), how heavily soiled the laundry is and the setting for the amount of liquid detergent according to the manufacturer's recommendations (see chapter *Tips before washing*).

INFORMATION!

Use of other non-homogenised or homemade liquid detergents can cause malfunction of the ADS. Any servicing required due to such problems shall not be covered by the warranty. The ADS function is tested with liquid detergents from the world's leading manufacturers. Do not mix different liquid detergents. When changing the liquid detergent, the tanks need to be cleaned.

Washing process, step by step (1 – 8)

Laundry ball or washing bag

If you are using a laundry ball or a washing bag, place it directly into the drum and choose a program without any prewash.

INFORMATION!

An excessive amount of detergent will not improve washing results. Rather, it will lead to foaming and increase the environmental impact. We recommend using less detergent. Only increase the dosage if you are not satisfied with the washing results.

Conditioner

Pour the conditioner into the detergent compartment, into the compartment with the symbol . Observe the recommendation on the conditioner packaging.

INFORMATION!

Do not fill the conditioner compartment over the max. indication (maximum indicated level). Otherwise, the conditioner will be added to the washing machine drum too soon, leading to poorer washing effect.

Washing process, step by step (1 – 8)

STEP 5: Choose the program



Washing programs and other settings can be selected and confirmed as follows:

- by rotating the selector knob in either direction and pressing it in the middle to confirm,
- by touching the screen.

Choose the program depending on the type and dirt level of laundry (see chapter *Tips before washing*).

Estimated program duration will appear on the screen.



On the selected program, you can touch  *Information* to display a brief description of the program and the maximum load.

Extra program settings can also be selected for each program. See *STEP 6: Choosing the program settings*.

Program chart

Program	Capacity (kg)	Spin Speed (rpm)	Description
Normal	9.5 FL	1600	Washing cycle, which is able to clean normally soiled cotton laundry declared to be washable at 40°C or 60°C. Use Normal program to clean normally soiled cotton laundry.
White laundry cold–90°C	4.25 HL	1400	Use the white laundry program for normally to heavily soiled white laundry. Select a lower temperature for less soiled laundry and a higher temperature for heavily soiled clothes.
Coloured laundry cold–60°C	4.25 HL	1200	This program is used for washing coloured laundry using special purpose detergents for coloured laundry. We recommend turning dark garments inside out.
Mix/Synthetics 2) cold–60°C	4	1200	The MIX/Synthetic program is adapted for clothing made of synthetic and mixed fibres or viscose and for easy care of cotton laundry.

Washing process, step by step (1 – 8)

Program	Capacity (kg)	Spin Speed (rpm)	Description
Delicates cold–40°C	4	800	Program for delicate clothing made of synthetic and mixed fibres, and for simple care of cotton or viscose. It may also be used for pillows, quilted jackets and similar items, as it uses a lot of water for the wash. Carefully read the washing instructions. If the outer layer has a membrane, do not use a conditioner. Washing temperature can be set up to 40 °C, and spinning speed can be set up to 1000 rpm.
Wool/Hand wash cold–40°C	3	800	Gentle washing program for washing wool, silk, and clothes that require manual washing. Maximum temperature is 40°C. This programme has a short spinning cycle. Top spinning speed available is 1200 rpm. Do not use conditioner with this program!
Sportswear 30°C–60°C	4.5	1200	This program is suitable for washing clothing with membranes, waterproof clothing, and breathable clothing, requiring simple care. It is suitable for sportswear made of mixed materials. It combines low temperature with gentle tumbling. Do not use conditioner with this program!
Outerwear cold–40°C	4.5	800	The program is suitable for washing winter jackets, coats and all outerwear that is heavily soiled.
Time program cold–60°C	2	1400	Use the Time program to set the program time, from 20 minutes to 2 hours. Be sure to choose the time and temperature appropriate to the degree of soiling of the laundry.
Jeans cold–40°C	4.5	1200	Program for washing jeans. Due to a higher water level and an extra rinse, there will be no traces of detergent on the jeans. It uses low temperature and 1200 rpm.
Shirts/Blouses cold–60°C	4	1000	This program washes the collars and cuffs without wrinkling them. The wash takes place at a low temperature, with a greater amount of water and gentle tumbling.
Bedding/Towels 30°C–90°C	6	1400	This program is used to wash bedding, pillows, and larger items. Weekly wash of your bedding will remove skin residue and mites.
Down cold–40°C	4.5	1200	Use this program to wash blankets, coats, vests or jackets. Place garments in the machine so they don't touch the rubber seal or the glass.

Washing process, step by step (1 – 8)

Program	Capacity (kg)	Spin Speed (rpm)	Description
Steam Refresh	2	/	The program allows clothes to be softened and disinfected. Steam refresh reduces or eliminates the need for ironing. After steam refresh the laundry may be slightly damp or contain minor traces of water.
Quick PRO 40°C–60°C	4	1600	A quick program with high efficiency for smaller amounts of lightly soiled laundry. The program washes with intensive tumbling and MAX rpm.
Stain program Cotton 30°C–90°C Synthetics 30°C–60°C	Cotton 9.5 FL Synthetics 4.5	Cotton 1400 Synthetics 1200	Choose the fabric and stain type from the menu, and the right stain removal program will be automatically selected. You can choose between the following types of stains: red wine, blood, grass, blueberries, fruits, chocolate, coffee/tea, egg, dairy products, tomato sauce, butter/grease, kids mess. After selecting the type of stain, select the type of fabric (Cotton or Synthetics) and washing temperature for the selected type of fabric. See chapter "TIPS BEFORE WASHING". You can also choose the spinning rate.
Waterproofing	4.5	400	For impregnating garments with special agents that increase water resistance.
Anti-allergy Cotton 60°C–90°C	5	1400	This program is used to wash normal to heavily soiled clothes that require special care, such as clothes for people with highly sensitive skin or skin allergies. We recommend turning the garments inside out as this will also thoroughly wash out the skin and other residues. You can also select the option to wash at maximum temperature and maximum spinning speed. Set temperature will be maintained for a longer time period than on conventional programs in combination with intense agitation and extra rinses.
Anti-allergy Synthetics 60°C	4.5	1200	This program is used to wash synthetics clothes that require special care, such as clothes for people with highly sensitive skin or skin allergies. The program is also suitable for people sensitive to washing detergents. We recommend turning the garments inside out as this will also thoroughly wash out the skin and other residues. Set temperature will be maintained for a longer time period than on conventional programs in combination with intense agitation and extra rinses.
Textile trainers cold–40°C	2	800	The Textile trainers program is adapted for washing sports shoes with gentle movements and a low spin speed.
Soft toys cold–60°C	4	1200	Program for fluffy toys, gentle and effective.

Washing process, step by step (1 – 8)

Program	Capacity (kg)	Spin Speed (rpm)	Description
Underwear cold–90°C	2	1200	Use the Underwear program to wash delicate underwear. Small amounts of laundry must be washed in a protective bag.
Swimwear cold–40°C	2	1200	For your delicate swimwear, remove the salt and prolong the fabric.
Baby clothes cotton 40°C–90°C	4	1400	This programme is used for washing clothes that require special care, such as baby clothes or clothes for people suffering from skin allergies.
Rinse	9.5 FL	1600	The program is suitable for laundry that only needs rinsing, and for cleaning cloths or mops.
Spinning	9.5 FL	1600	Use the program when you only wish to spin the laundry.
Drain		/	If you only wish to pump out the water from the washing machine, choose the Drain program.
Drum Cleaning		/	This programme is used for cleaning the drum and removing the residue of detergent and bacteria. Other extra functions cannot be selected. The drum must be empty. Do not add detergent or softener! You can add some spirit vinegar (approx. 2 dl) or sodium bicarbonate (1 tablespoon or 15 g) for effective descaling. We recommend that you use the program at least once a month.

2) Information for test institutes: During a test in compliance with the applicable standard EN60456, you must select the maximal possible spin speed.

FL Full load

HL Half load

cold Cold wash



INFORMATION!

In terms of energy and water consumption, programmes that operate at lower temperatures and last longer are generally the most efficient.



INFORMATION!

Noise and residual moisture content are affected by the spinning rate: the higher the spinning rate in the spin cycle, the higher the noise and the lower the residual moisture content.

Washing process, step by step (1 – 8)

Recommendations for detergents under Regulation (EU) No. 1015/2010

Program	Detergent			
	Universal	For coloured laundry	For delicate laundry and wool	Special
Normal	✓	✓		
White laundry	✓			✓
Coloured laundry	✓	✓		
Mix/Synthetics	✓	✓		
Delicates			✓	✓
Wool/Hand wash			✓	✓
Sportswear		✓	✓	✓
Outerwear		✓	✓	✓
Time program	✓	✓		
Jeans		✓	✓	
Shirts/Blouses		✓	✓	
Bedding/Towels	✓	✓		
Down		✓	✓	
Steam Refresh				
Quick PRO	✓	✓		
Stain program	✓	✓		
Waterproofing		✓	✓	✓
Anti-allergy Cotton	✓	✓		✓
Anti-allergy Synthetics	✓	✓		✓
Textile trainers	✓	✓		
Soft toys	✓	✓		
Underwear		✓	✓	
Swimwear		✓	✓	
Baby clothes cotton	✓	✓		✓
Rinse				
Spinning				
Drain				
Drum Cleaning				

✓ Choice of options

STEP 6: Choosing the program settings

Using the program settings, the washing programs can be further adjusted to your wishes.

Some programme settings that were selected remain saved after the wash has finished, and you can change them afterwards.

In the selected programme, you can choose between three quick access settings without entering the programme settings. By directly touching the desired setting, you can change the selection.

Washing process, step by step (1 – 8)

Quick access allows you to set:

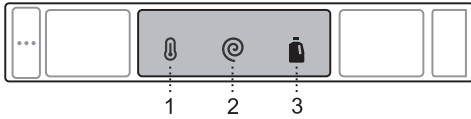

1. Temperature
2. Spin
3. Dose

For a programme that does not have any of the above settings, quick access is not possible.

INFORMATION!

Some program settings may not be available for your selected program.

For the full set of programme settings, select the programme and enter the programme settings.



Choose the program settings before pressing **Start/Pause**.
When a washing program is in progress, program settings cannot be changed.

The following programme settings may be selected:

Set time

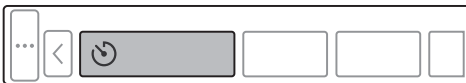

You can choose the duration of the washing from 20 minutes to 2 hours in steps of 15 minutes.

This setting is only possible in the *Time* program.

Stain



You can choose between the following stains: red wine, blood, grass, blueberries, grease, chocolate, tea/coffee, egg, dairy products, kids stains, fruit or tomatoes.

This setting is only possible in the *Stains* program.

Mode



Set the washing mode according to the amount of water and the washing time.

The following washing modes are available:

- *Default mode*
(Basic setting)
- *(Eco) Green mode*
(Wash that saves energy; lower water consumption).

Washing process, step by step (1 – 8)

- >> *Speed mode*
(Time-saving wash; shorter washing times, higher water and energy consumption).
In the Normal program, we recommend a half-load.
- 🧺 *Intensive mode*
(Wash that improves cleaning performance, with extra water and extended washing time).
- 🌙 *Night mode*
(Wash that reduces noise and extends washing time.)

🔒 Temperature



The actual available temperature options, will depend on the selected program.

The following temperatures are available for the selected program:

Cold wash and 20/30/40/50/60/70/80/90 °C.

@ Spin



The following spinning rates are available for the selected program: max. (rpm) /... / no Drain (max. rpm = depends on the model).

Default setting is 1400 rpm; it depends on the selected program (spin rate can be changed – reduced or increased (only in some models)).

The actual available spin speed will depend on the selected washing program.

💧 Dose

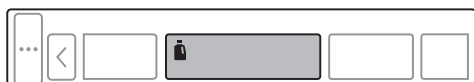

There are several different ways to dispense detergent:

- Manual dose,
- Manual assist,
- Auto dose (ADS) Auto Dose System (ADS).

For detailed ADS menu settings, see chapter *Special features*.

⊖ Small load



The small load function adjusts the use of water and energy to ensure thorough washing while reducing waste. The small laundry load can be activated to show the correct time if you add up to 2,5 kg of laundry.

Washing process, step by step (1 – 8)

Steam disinfection



Steam disinfection is a low temperature disinfection cycle.

Before the start of the main wash, steam is supplied to the washing machine to disinfect your clothes.

Prewash

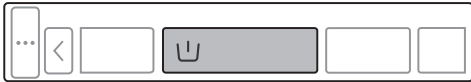

To use prewash before the main wash, choose the Prewash option. Use of this setting is recommended for heavily soiled laundry or for laundry with stubborn surface stains.

Confirm your selection by pressing the On / Off button .

In the event that the ADS is switched off, the prewash setting cannot be selected, also the prewash is not implemented with the programs where it is preset.

Prewash cannot be selected on some programs. When Speed Mode is selected, the prewash is automatically switched off.

Super rinse



Choose between **turning on** or **turning off** the additional rinse phase.

The setting helps to ensure that the clothes are rinsed thoroughly without leaving behind any detergent residue or dirt. This is recommended for persons with highly sensitive skin and/or in areas with very soft water. The setting allows for double extra rinsing.

High water level



The High Water Level option increases the amount of water used during the main wash and rinsing phases and is available with certain programmes.

This setting enables more thorough washing and rinsing for heavily soiled laundry, better care of larger or delicate fabrics, and more effective removal of stains and detergent residues.

Confirm your selection by pressing the On / Off button .

Rinse and hold



This setting does not include a final spin cycle. If set to **On** , the laundry will remain in the final rinse water after washing has finished, awaiting your next selected step.

You can resume in the following ways:

Unlock the door: the machine drains the water and stops the program.

Washing process, step by step (1 – 8)

Spin and finish: spinning is carried out and the wash is completed.

The purpose of the setting is to prevent the garments from developing a bad smell, as it allows you to complete the program after several hours when the user determines how to resume and complete the spin cycle.

Anti crease



To prevent creasing, select the Anti-crease function (gentle tumbling). This function is recommended for delicate laundry.

Confirm your selection by pressing the On  / Off button .

It will be carried out after the washing cycle.

Delay start



Choose the delayed start setting when you wish the washing program to start after a certain period of time.

You can choose a start delay time from **30 minutes** to 6 hours in 30-minute steps, and then from 6 hours to 24 hours in 1-hour steps.

Press the **Start/Pause** button to start. When the countdown reaches zero, the selected washing program will start automatically.

If you do not take any action for 5 minutes, the screen will turn off.

By pressing the On/Off button (On/Off) you can reactivate it. The display will show the countdown to the start of the washing cycle.

The display will activate 1 minute before the start of the washing cycle.

After the countdown, washing time will be indicated on the display.

If you want to cancel the delayed start and initiate the washing process immediately, press Skip. When the Delayed start is already set, it can be cancelled by pressing the Start/Pause button for 3 seconds to return to initial selection.

INFORMATION!

If you have set the delayed start function and you are using liquid detergent, we do not recommend choosing a programme with a pre-wash cycle.

Add to favourite



By selecting the setting *Add to favourite*, you enter the menu to add your favourite programmes. Confirm the selection by pressing *Yes*.

Next to the selected programme, the following icon will light up . The programme will be stored. By pressing *Cancel*, you cancel adding the programme to favourites.

You can store up to 6 favourite programmes.

Washing process, step by step (1 – 8)

- **Removing a favourite programme**

When all 6 slots are taken, it is not possible to set a new programme.

To add a new favourite programme, you need to delete an existing one beforehand.

To remove a favourite programme, select the programme you want to remove. Select the setting *Add to favourite* and confirm the removal of the favourite program by touching *Yes*. The programme will be removed.

STEP 7: Start the wash

Close the washing machine door.

To start the programme, follow these steps:

1 Press the **Start/Pause** button.

2 When the message »All set? Door will lock.« appears on the screen, press »**Confirm**« button in 60 seconds.

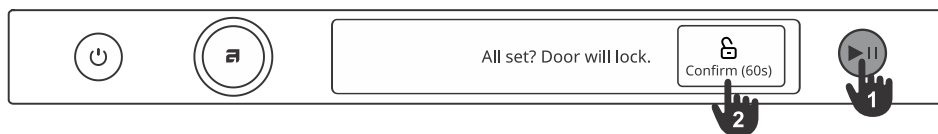

If no confirmation is made within 60 seconds, the start sequence will be cancelled. To start the programme, press the Start/Pause button again and repeat the confirmation.

By pressing the **Start/Pause** button, you can start or resume the washing programme and temporarily pause the programme.

Cancel (press and hold the button for 3 seconds)

Time remaining

Depending on the selected program, anticipated washing time will be displayed in hours and minutes.

Actual washing time will depend on the selected program, load, type of laundry, spin speed etc.

Actual washing time may be longer or shorter than initially displayed.

Remaining time will be updated during the program duration, depending on the actual amount of laundry and amount of water pumped into the machine. The last remaining time update takes place before the final spinning cycle.

In case of uneven distribution of laundry, the time on the display will flash and it will not count down. Once the laundry is evenly redistributed, the washing time will continue and it will stop flashing.

Adding or removing laundry after the start of the program

To add or remove laundry during the progress of a washing program, use the Start/**Pause** button to stop the program and then select Add clothes.

The door may be opened when the water is pumped from the machine (but not completely pumped out). Then, add or remove the laundry. Close the door and resume the program. Press **Start/Pause**.

The program will resume from the point at which it was interrupted.

Washing process, step by step (1 – 8)

If the door cannot be opened, it is possible that the temperature in the machine is too high, and you won't be able to add the laundry.

Also, if the door cannot be opened, it is possible that the program has been running for too long and any laundry added at that point would not be efficiently washed.

Pausing, stopping or changing the program

To pause the programme, briefly press the Start/**Pause** button.

If you wish to continue with the programme, press the **Start**/Pause button again and confirm your selection by pressing »*Confirm*«.

To stop the washing program, press the Start/**Pause** button and hold it for 3 seconds.

Select Stop program. The program is cancelled and the water is pumped out of the machine if necessary. Only then can you open the washing machine door. Use the program selector knob to select a new program, add detergent if necessary, and press **Start**/Pause.

INFORMATION!

If the temperature in the drum is very high, then cooling procedure starts before program is canceled.

By pressing On/Off the Washing program can be interrupted.

The washing machine will switch off.

After the appliance is switched back on, press the **Start**/Pause button to resume the program.

INFORMATION!

Do not open the detergent compartment while the appliance is operating.

INFORMATION!

In some cases the door may be locked although no program is in progress (e.g. in case of an error). To unlock the door, press the Start/Pause button and hold it for a while.

STEP 8: End of program

After the end of the washing program, the display will indicate that the program has been successfully finished.

You can open the door.

If you have additionally selected the Anti crease function, gentle tumbling will continue after the end of the washing program in order to prevent creasing.

Open the door towards you and remove the laundry from the washing machine.

Make sure the washing machine drum is empty.

If you do not take any action within 5 minutes after the end of the program, the display will switch off to standby mode in order to save power.

Washing process, step by step (1 – 8)

The screen will light up again if you press any of the buttons or the screen.

WARNING!

After the washing cycle, close the water tap and pull out the washing machine plug from the power socket.

Additional service settings

In the main menu, select Additional settings.



Press  in any setting to return to the Main menu.

You can choose between the settings below:

LOCK



Use the setting to disable the on-screen buttons so that children may not inadvertently trigger or change the cycle.

Choose between **turning on**  or **turning off**  the lock.

While the lock is activated, the washing machine will lock automatically after 1 minutes of inactivity. The setting cannot be switched on manually.

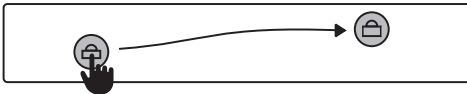

When you want to resume using the washing machine, touch the screen or rotate the selection button. You can unlock the locked screen by swiping the left icon to the right lock icon or by pressing both icons at the same time.

When the Lock is activated, no other function can be selected.

AA EASY VIEW

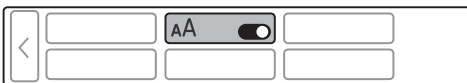

The setting allows for a more transparent display of the menu with a reduced number of symbols and descriptions.

Choose between **turning on**  or **turning off**  the easy view.

DRYER LINK



Choose between **turning on**  or **turning off**  the connection with the dryer.

The setting must be switched on on the washing machine and dryer for operation.

In the ConnectLife app, connect the appliances. When the dryer and the washing machine are connected, the dryer proposes an appropriate drying program according to the program that is carried out in the washing machine.

Appliance settings

📶 Wi-Fi SETTINGS



Choose between **turning on** or **turning off** the Wi-Fi connection.

Refer to the setting procedure in the chapter Before first use *How to enable Wi-Fi on the device?*.

For status information, select the Status option.

🌿 ECO STATUS



Five-leaf programmes have a minimal impact on the environment, as they allow you to save resources and save energy. These programmes are good for sustainable washing practices.

By washing more fabrics each time you start the program, you can optimise the energy efficiency of the appliance and save money. For more sustainability, wash full loads.

⚙️ SYSTEM SETTINGS



In the main menu, select Additional service settings and then select System settings .

In System settings, you can check the following:

🔄 Cycle counter



Display of the number of cycles performed.

☰ Machine status



In the appliance status settings, you can review or set the following options:

- **Notifications**

Choose between **turning on** or **turning off** the notifications. If the setting is turned off after the end of washing, no cleaning notifications will be displayed.

- **ADS (Auto Dose System)**

Scan the QR code for instructions on how to clean the ADS system. After cleaning, confirm the completion of the task by pressing »Cleaned«.

- **Drum cleaning**

To clean the drum, run the Drum cleaning program . Carry out the cleaning once a month with distilled vinegar (2 dl) and bicarbonate solution (15 g) to remove the limescale and freshen up the drum.

- **Cleaning the filter**

Scan the QR code for instructions on how to clean the filter. After cleaning, confirm the completion of the task by pressing »Cleaned«.

When the error code E7 or E7.1 is activated, it connects to the filter cleaning instructions screen.

- **Error** (Failure read out)

The last three errors displayed to the user are displayed in the failure read-out menu.



For more information see chapter *Errors: what to do?*

Program management



The Main menu includes the entire set of programmes that you can choose from.

This setting allows only displaying the selected program in the Main menu.

The programme can be selected by pressing **Enable**  and **Disable**  display. Favourite programmes and Drum Cleaning cannot be disabled. Pressing and holding the selected programme for **3** seconds allows you to **arrange the order** of your choice.

Reset program list





By selecting the Reset program list setting all favourite programs and their order, if it has been changed, will be deleted. Other settings will not be affected.

Confirm the reset by touching the Ok button. To cancel programme reset, do so by tapping the Back button .

Display logotype



The display of the logo can be enabled or disabled by pressing **Enable**  or **Disable** .

Sound volume

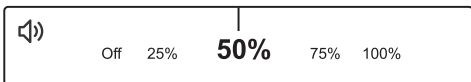

You can choose between muted sound, 25%, 50%, 75% or 100% volume.

Display brightness

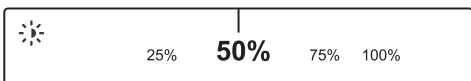



You can set the **Brightness** on the screen.

You can choose between 25%, 50%, 75% or 100% screen brightness.

Appliance settings

Drum light



By pressing Drum light you can choose between **turning on**  or **turning off**  the drum light.

Choose Language

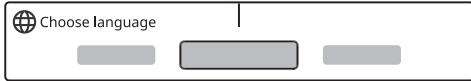

You can choose between different languages. Scroll left or right to navigate the list of languages.

Air shower



This function adds air into the wash process, improving detergent dissolution for better fabric care and more effective stain removal.

Automatic extra rinsing



You can set the automatic double extra rinsing for each wash. The setting helps to ensure that the clothes are rinsed thoroughly without leaving behind any detergent residue or dirt.

Water hardness



Choose water hardness between the following settings: soft / normal / hard.

Water hardness can be measured with the measuring strip. Check the information on water hardness with your local water supply company or authority.

Water hardness is determined using the following scales: the German water hardness scale (°dH) and the French water hardness scale (°fH).

Water hardness	Hardness levels			
	°dH (°N)	m mol/l	°fH(°F)	p.p.m.
1 – soft	< 8.4	< 1.5	< 15	< 150
2 – normal	8.4 - 14	1.5 - 2.5	15 - 25	150 - 250
3 – hard	> 14	> 2.5	> 25	> 250

If the water hardness exceeds 50 °dH (89 °fH), we recommend the connection of an external water softener.

Contact your local water supplier, or measure the water hardness using the supplied test strip, to check the water hardness in your area.

Test strip		°dH	°fH
4 green		< 3	< 5
1 red		> 4	> 7
2 red		> 7	> 12
3 red		> 14	> 25
4 red		> 21	> 37

How to use the test strip:

1. Turn on the water tap and let the water run for a minute or so.
2. Fill a glass with cold water.
3. Remove the test strip from its packaging.
4. Dip the test strip in the water for about one second.
5. Wait one minute. Now compare the colours of the squares with the water hardness table.

Temperature unit

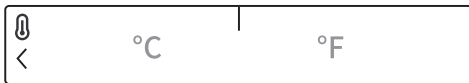

Set the unit of measurement for temperature:

- Celsius **°C** or
- Fahrenheit **°F**.

Liquid unit

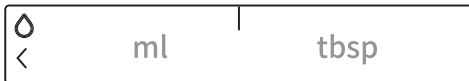

Set the unit of measurement for liquids:

- Millilitres **ml** or
- Tablespoons **tbsp**.

Weight unit

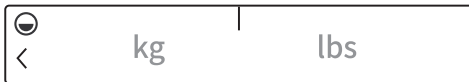

Set the unit of measurement for weight:

- Kilogrammes **kg** or
- Pounds **lbs**.

Shop mode



The appliance simulates the display and operation of the normal cycle for silent visual display. Only for stores.

Choose between **turning on** or **turning off** the shop mode.

Confirm the reset by touching the Ok button. In this case, you will automatically return to the main menu.

Factory default settings

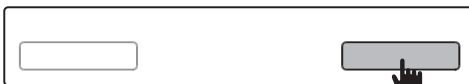

By selecting Factory default settings you will revert the settings to the original settings (your own settings and all favourite programs will be deleted).

Confirm the reset by touching the OK button.

Cleaning and maintenance

Cleaning the dispenser tray

 **ELECTRIC SHOCK!**

Always disconnect the washing machine from the power mains before cleaning.

 **INFORMATION!**

Cleaning the ADS system is very important for the correct operation of the appliance! Clean the empty container of the ADS system regularly, at least once a month or with every other filling.

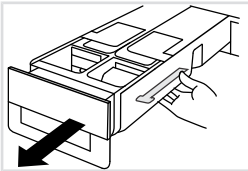

1 On the right side of the lower part of the dosing container, press on the release mechanism and completely remove the dosing container from its housing.

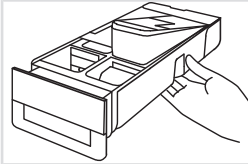

2 On the underside of the dosing container, push into the opening of the left and right compartment of the ADS to remove the tank from the dosing container.

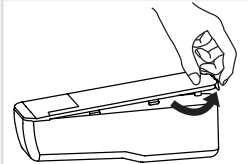

3 Remove the tank cover using the tab on the rear side.

Rinse the tank under water and clean thoroughly. You can help yourself with a brush.



4

Also open the tank cap and clean it.

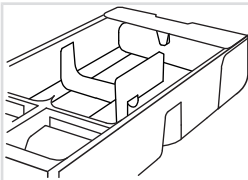

5

Clean the dosing container interior.

Cleaning and maintenance

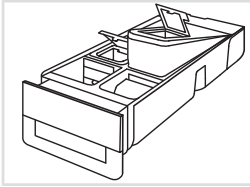

6

Reinstall the tank into the housing of the dosing container.

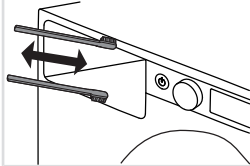

7 Use a brush to clean the nozzles on the upper side of the detergent compartment housing.

Use a brush to clean the lower part of the detergent compartment housing.

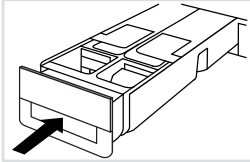

8 Put the dosing container back into its housing and close it.

💡 INFORMATION!

When cleaning the dosing container, always remove the concentrated detergent and softener residues. Also clean the bottom of the dosing container housing.

The dosing container can be washed in the dishwasher; before that you must remove any residues of detergent or softener. The maximum allowed washing temperature in the dishwasher is 55°C.

Cleaning and maintenance

Cleaning the filter

The washing machine has a filter that will retain smaller objects such as coins, buttons, hair etc.

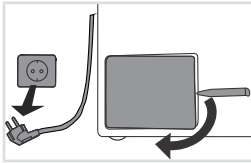

1 Before cleaning, drain the water from the washing machine using the Drain program, and disconnect the washing machine from the power mains.

Open the pump filter cover using appropriate tools (the door opening tool is located on the front right side of the dosing container).

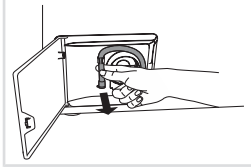

2 Release the water drain hose from the holder.



3 Before cleaning the filter, drain the water from the washing machine by placing the end of the water drain hose over a large shallow container and opening the cap on the water drain hose.

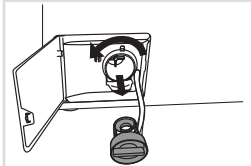

4 Gradually rotate the filter in the counter-clockwise direction and pull it out.

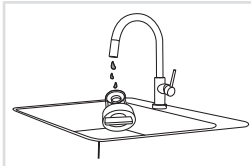

5 Clean the filter thoroughly under running water.

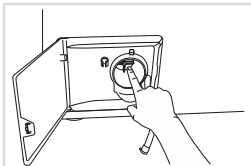

6 Remove all objects and impurities from the filter housing and the impeller.

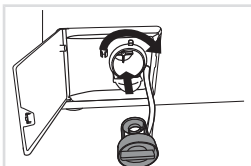

7 Replace the filter as shown in the figure and fasten it by rotating in the clockwise direction. For a good seal, the filter seal surface should be clean.

Reattach the drain hose and close the lid.

💡 INFORMATION!

We recommend regular cleaning of the pump filter once a month. When washing very fleecy, very dirty or old laundry, do it more often.

Cleaning the appliance exterior

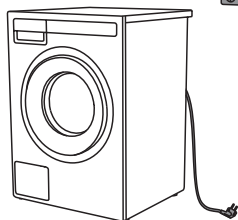

📷 Clean the appliance exterior and the display using a soft damp cotton cloth and water. **Do not use any solvents or abrasive cleaners that could damage the appliance** (please observe the recommendations and warnings provided by the manufacturers of the cleaning agents).

💡 INFORMATION!

Do not clean the machine with a jet of water!

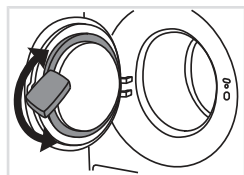

After every wash, wipe the rubber door gasket and remove any objects that may have become stuck in the gasket to extend its useful life.

Cleaning the washing machine interior against odours

Modern detergents often allow washing clothes at low temperatures. This means that residue may accumulate in the washing machine, which in turn could cause odours.

To avoid bad odours, we recommend running the Drum Cleaning program once per month. Use a small amount of powder detergent, without any laundry.

If you are using hard water

If you are washing with hard water (high limescale content), a greyish-white coating may appear on the washing machine drum. Remove this coating by pouring alcohol vinegar (pickling vinegar) into the washing machine drum (approx. 2 dl) or sodium bicarbonate (1 tablespoon or 15 g) and select any program in which the temperature reaches 90 °C or the Drum cleaning program. See chapter *STEP 5: Program chart*.

Repeat the process as necessary.

For the water hardness adjustment procedure see chapter *Appliance settings/ Water hardness*.

Errors: what to do?

Disturbances from the environment (e.g. the power grid) may result in various error reports (see table below: Fault/Error). In such case:

- Switch off the appliance, wait for at least 1 minute, switch on the appliance again and repeat the washing program.
- If the error persists, call an authorized service center.
- Most **interferences** during operation can be resolved by the user (see table below: Fault/Error).
- **Repairs** may only be carried out by an adequately trained person.
- Repair or any warranty claim resulting from incorrect connection or use of the washing machine shall not be covered by the warranty. In such cases, the costs of repair shall be charged to the user.

INFORMATION!

The warranty does not cover the errors or failures resulting from disturbances from the environment (lightning strike, power grid failures, natural disasters etc.).

The following lists all the errors that the user can see on the user interface.

Problem/error	Cause	What to do?
Washing machine door does not open.	Water level too high.	Drain the water using the Drain program or the Spinning program. See chapter STEP 5/ <i>Program chart</i> .
	Water temperature in the washing machine is too high.	Wait for the water temperature to drop and pump out the water. If you still cannot open the door, use the emergency door opening tool (see chapter <i>Errors: what to do?/Manual opening of washing machine door</i>).
The machine will not start.	Power supply failure.	Press the OK button to resume the program.
Washing program is not in progress.	Washing machine door is not properly closed.	Firmly press on the washing machine door until you hear two clicks when it is closed.
	There is no voltage in the power outlet.	Check if the plug is connected to the power outlet and whether there is electric current (or voltage) in the outlet.
	Delayed start function has been selected.	To cancel the delayed start function, press the OK button for three seconds.

Problem/error	Cause	What to do?
Washing time is longer than anticipated (the time is regularly updated on the display unit).	Low inlet water temperature.	Program duration can be up to 60% longer than initially anticipated in the normal progress.
	UKS* (*unbalance system) stability system engaged due to unevenly distributed laundry.	Program time is extended due to the need to redistribute the laundry in the drum.
	Low mains voltage.	Washing machine needs more time because the power mains voltage is too low.
	Power supply failure.	Program time is extended by the duration of the power supply failure.
Display does not light up.	There is no voltage in the appliance.	Check if the plug is connected to the power outlet and whether there is electric current (or voltage) in the outlet.
The wording on the display unit is not in your language.	You have not selected your preferred language yet.	Choose the appropriate language (see Additional settings: System settings / <i>Choose Language</i>).
Wet laundry ("unbalance" will appear on display)	A small amount of laundry will often be unevenly distributed.	Loosen and redistribute the laundry and select the Drain program or the Spinning program . Increase the amount of laundry in the washing machine and restart the program (see <i>STEP 7/ STEP 7: Start the wash</i>).
There are traces of grease (or grease rolls) on the clothes.	The laundry was very greasy.	Wash the laundry again. When your laundry is this heavily soiled, add more washing powder or use a liquid detergent in combination with a more powerful (longer) program.
There are still stains on the laundry.	You used bleach-free liquid detergent or powder detergent for coloured laundry.	Use a detergent that contains bleach.
	You selected an unsuitable program.	Use special stain removers.
There are white residues of washing powder on the laundry.	This is not due to poor rinsing by your washing machine, but rather due to phosphate-free detergents which contain ingredients (zeolites) for water softening. These ingredients may be deposited on the laundry.	Immediately rinse the laundry again. Use liquid detergents that do not contain zeolites. Try removing any residues with a brush.

Errors: what to do?

Problem/error	Cause	What to do?
There is powder detergent left in the main wash compartment of the detergent detergent compartment.	Water pressure not high enough.	Clean the net on the water supply hose.
	Some washing powders may stick strongly to the detergent compartment if it is empty.	Choose High water level or Extra rinse (see <i>STEP 6: Choosing the program settings</i>). Wipe the detergent compartment before adding the powder detergent.
There is conditioner left in the conditioner compartment of the detergent compartment.	Plug cap is not positioned correctly or it is clogged.	Make sure the plug cap in the softener compartment of the detergent compartment is positioned correctly. Clean the plug cap (see chapter <i>Cleaning and maintenance/ Cleaning the dispenser tray</i>).
Odour in the washing machine drum.	Residues of fabric, washing detergent, and conditioner in the filter.	Check if the filter is clean.
	Development of germs and bacteria.	Choose the Drum cleaning program (see <i>STEP 5/ Errors: what to do?</i>).
Machine is moving during operation.	Feet not adjusted correctly.	Level the feet (see chapter <i>Installation and connection/ Adjusting the washing machine feet</i>).
	Transport bolts not removed.	Remove the transport bolts (see chapter <i>Before using the appliance for the first time/ Transport protection</i>).
Machine is moving during spinning.	Unevenly distributed laundry or not enough laundry.	The washing machine will automatically decrease the spin speed if vibration is too strong. Increase the amount of laundry in the washing machine and restart the program (see: <i>STEP 7: Start the wash</i>).
Noisy (loud) drain pump	Drain pump filter is clogged. Filter housing and drain pump impeller are clogged.	Make sure the drain pump filter is clean. Make sure the filter housing is clean. See chapter <i>Cleaning and maintenance/ Cleaning the filter</i> .

Manual opening of washing machine door

ELECTRIC SHOCK!

Washing machine door may be opened **manually** if the appliance is not connected to the power mains and if the water has been pumped out of the machine.

- A. Choose the program Spinning or Drain to drain the water from the machine. If this does not work, water has to be drained from the washing machine drum manually. See chapter *Cleaning and maintenance/ Cleaning the filter*.
- B. Make sure the main switch is off and that the plug is disconnected from the power outlet.
- C. You will need to use a flat-blade screwdriver (1) (the screwdriver is not included). Insert the flat-blade screwdriver into the emergency door opening hole on the right side of the washing machine door lock to push the "wheel" inwards and turn it clockwise until the washing machine door opens. Do not use too much force to open the door with a screwdriver.

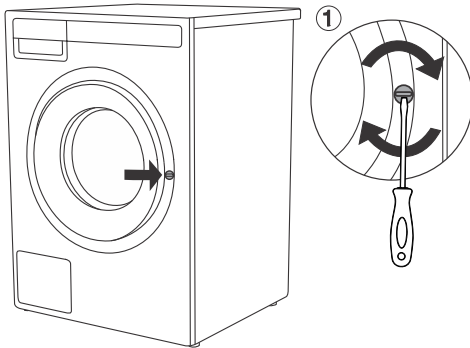

INFORMATION!

If the washing machine door still cannot be opened, call a service technician.

INFORMATION!

The door lock is motorised, which may cause noise during locking and unlocking. This is a normal condition and no cause for concern.

Errors: what to do?

Failure display

In case of a failure while a program is underway, Error X is indicated on the display. Press and hold the Ok button to display the error description on the display. Switch off the appliance and turn it back on.

Errors indicated on the screen unit (depending on the model) may include the following:

Error	Error indication on the display and error description	What to do?
E0	Incorrect settings	Restart the program. If the error reoccurs, call a service technician.
E1	Temperature sensor error.	Inlet water too cold. Repeat the washing program. If the appliance reports this error again, call a service technician.
E2	Door lock error.	Example 1: The door is closed, but an error appears <ul style="list-style-type: none">• Check that the door is properly closed. Switch off the appliance using the ON/OFF button,• switch the appliance back on and wait for approximately 10 seconds. The door lock will reset automatically. Example 2: The door cannot be closed. <ul style="list-style-type: none">• Switch off the appliance and disconnect it from the mains,• use a flat screwdriver and open the door (see the previous chapter: "<i>Manual opening of washing machine door, section C</i>").• when the door is released, close the door,• connect the appliance to the mains supply and continue with the steps from Example 1. If the error reoccurs, call a service technician.
E3	Water filling error	Check the following: <ul style="list-style-type: none">• is the water inlet valve open,• is the filter on the water inlet hose clean,• is the water supply hose deformed (clipped, clogged etc.),• is the pressure in the water mains between 0.1 - 500 kPa (1–5 bar).• is the height of the drain hose is at the proper level (see chapter <i>Installing the drain hose</i>), and then press the OK button to resume the program. If the error reoccurs call a service technician.
E6	Water heating error	Restart the program. If the error reoccurs, call a service technician.
E7	Water draining error	Check the following: <ul style="list-style-type: none">• is the pump filter clean,• is the drain hose clogged,

Error	Error indication on the display and error description	What to do?
		<ul style="list-style-type: none"> • is the drain clogged, • if the drain hose is placed below the maximum and above the minimum height (see chapter <i>Installation and connection/ Connecting the water drain hose</i>), • if you have used too much detergent (a larger amount of foam may form in the drum), • and remove any objects and debris from the filter housing and rotor. <p>then, press the Exit button again. If the error reoccurs, call a service technician.</p>
E7.1	Drain system alert	Alert about reduced water flow in the pumping stage. Check how to clean the pump filter (see chapter <i>Cleaning and maintenance/ Cleaning the filter</i>).
E7.2	Excessive amount of detergent	Too much detergent may cause excessive foaming in the drum.
E9 E9.1	Water leak detected in the washing machine area	<p>Turn off the washing machine and turn it back on. Inspect the exterior of the appliance. If you do not observe any leaks, you can continue to use the washing machine.</p> <p>Close the water valve and see chapter <i>Installation and connection/ Connecting the water drain hose</i> or call a service center.</p>
E10 E10.1	Water level sensor error	<p>Unplug the power cord from the outlet; then, plug the power cord back into the outlet and switch on the washing machine.</p> <p>Vent the appliance. Do this by draining and cleaning the washing machine filter and cleaning the wall-mounted trap.</p> <p>If the error reoccurs, call a service technician.</p>
E11	Overflow	<p>If there is water in the drum that exceeds a certain level, and an error is reported on the display unit, the washing program will be interrupted and water will be pumped out of the washing machine. Restart the programme. If the error reoccurs, call a service technician.</p> <p>If there is water in the drum that exceeds a certain level, and an error is reported on the display unit, while the washing machine continues to add water, close the water tap and call a service technician.</p>
E12	Motor error / motor control error	Restart the program. If the error reoccurs, call a service technician.
E13	Unevenly distributed laundry	Imbalance detected. Manually redistribute the laundry (stuck or tangled laundry) and repeat the washing program. If the error reoccurs, call a service center.

Errors: what to do?

Error	Error indication on the display and error description	What to do?
E22 E22.1	Error while locking the door	Door is closed, but it cannot be locked. Switch off the washing machine. Switch it back on and restart the washing program. If the error reoccurs, call a service technician.
E23 E23.1	Error while unlocking the door	Door is closed, but it cannot be unlocked. Turn off the washing machine, then turn it back on. If the error reoccurs, call a service center. To open the door, see chapter <i>STEP 7: Start the wash</i> .
E24	Error while unlocking the door	Door lock error. Restart the appliance; if the error reoccurs, call a service center.
E26	Error while locking the door	Exceeded locking current. Restart the appliance; if the error reoccurs, call a service center.
E36	Communication UI and PMCU Error in UI** and PMCU communication.	Turn off the appliance and turn it back on. If the error reoccurs, call a service technician.
E37	PMCU/UI** software versions are not compatible	Call a service technician.
E40	Warning from the system for detecting extended washing machine voltage fluctuation – $180\text{ V} > U > 260\text{ V}$	A prolonged drop of voltage do below 180 V, or voltage in excess of 260 V was detected, which can affect the washing machine operation. Check the power supply network to which your washing machine is connected.
E48	Appliance cannot be connected to the network.	The error only affects the option to remotely control (Remote control) your washing programme. it does not affect the washing process on other programmes. Call a service technician.
	Warning - Drum cleaning program	<ul style="list-style-type: none"> • clean the dosing container, • clean the water supply hose, detergent dispenser, and rubber door gasket, • clean the pump filter (see chapter <i>Cleaning the filter</i>) and • run the cleaning program (Drum cleaning) (see chapter <i>Program chart</i>). <p>This programme is used for cleaning the drum and removing the residue of detergent and bacteria. Other extra functions cannot be selected.</p> <p>The drum must be empty. Do not add detergent or softener! You can add some spirit vinegar (approx. 2 dl) or sodium bicarbonate (1 tablespoon or 15 g) for effective descaling. We</p>

Error	Error indication on the display and error description	What to do?
		recommend that you use the program at least once a month or whenever the warning appears.
	Preparation for unlocking the door.	Wait for the process to finish. If no errors are shown after the process, a new cycle can be run.

** UI = (User Interface)

Unevenly distributed laundry or lumps of laundry in the washing machine drum can cause problems such as vibration and noisy operation. The washing machine detects such problems and the UKS* (*stability control system) will be activated.

Smaller loads (e.g. one towel, one sweater, one bathrobe etc.) or clothes made of materials with special geometrical properties are virtually impossible to distribute evenly across the washing machine drum (slippers, large items etc.). This results in several attempts to redistribute the laundry, which in turn leads to longer programme duration. In extreme cases of unfavourable conditions, the programme can be completed without the spinning cycle.

The UKS* (*stability control system) allows stable operation and a longer washing machine useful life.

If the problems persist despite observing the advice above, call an authorized service technician.

INFORMATION!

Noise and vibration – make sure the appliance is levelled using the adjustable legs and that the jam nuts are securely tightened.

INFORMATION!

The warranty does not cover consumables, minor deviations in colour, increased noise that results from appliance age and which does not affect the functionality of the appliance, and aesthetic defects on components, which do not affect the functionality and safety of the appliance.

INFORMATION!

The warranty does not cover the errors or failures resulting from disturbances from the environment (lightning strike, power grid failures, natural disasters etc.).

Before calling a service technician

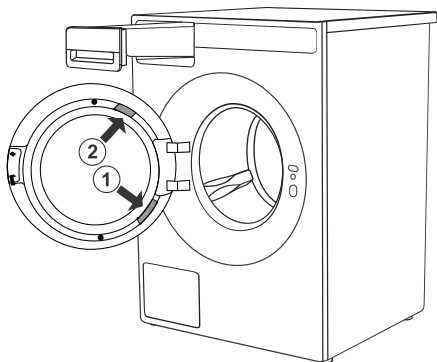

See chapters *Cleaning the filter*, and *Errors: what to do?* and see if you can resolve the problem yourself.

When you contact a service centre, please state your model number (2) and type (1) and the serial number (3) of the washing machine.

Model, type, and serial number are indicated on the rating (type) plate located on the interior side of the washing machine door.

The QR and AUID codes are located on the inside of the washing machine door as well.

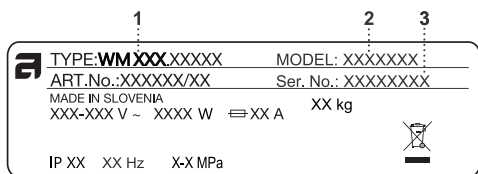

①

- 1 - Model type
- 2 - Model
- 3 - Serial number

②

- 4 - QR code
- 5 - AUID code

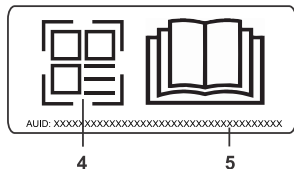

⚡ INFORMATION!

Report any malfunction to your local call centre or web address; all information can be found in the enclosed warranty statement. Contact details of your authorised service centre are available in the warranty statement supplied with the appliance and on the website by scanning the QR code on the rating plate (see chapter *Before calling a service technician*).

⚡ INFORMATION!

Some simple faults described in the chapter *Errors: what to do?* can be fixed by the user himself by taking into account the instructions without risk to their own safety and without affecting the warranty conditions.

⚠ WARNING!

In case of a failure, only use approved spare parts by authorized manufacturers.

WARNING!

Repair or any warranty claim resulting from incorrect connection or use of the washing machine shall not be covered by the warranty. In such cases, the costs of repair shall be charged to the user.

INFORMATION!

Functional spare parts for the ASKO washing machine you purchased will be available for 15 years. During this time, original spare parts will be available to ensure the correct operation of your appliance.

A list of spare parts and repair tips in accordance with the current Ecodesign Directive can be found by scanning the QR code located on the inside of the door of the washing machine.

Or on the following link: <https://aid.connectlife.io>

Technical information

Technical data	
Height	850 mm
Width	595 mm
Depth	626 mm
Drum volume	68 l
Rated power	See rating plate
Heater power	See rating plate
Water pressure	0,1–500 kPa 1–5 kp/cm ² 10–50 N/cm ²
Washing drum and tub material	Stainless steel
Housing material	Hot-dip galvanized and powder coated sheet metal, or stainless steel sheet (depending on model)
Water connection	1.5 m, Aqua stop (straight)
Drain hose	1.6 m polypropylene hose

Typeface License Notice

This product includes the Noto Sans font, which is licensed under the SIL Open Font License, Version 1.1.

The full text of the license is available at: <https://openfontlicense.org>

Noto Sans is an open-source typeface developed by Google, and it may be used, modified, and redistributed under the terms of the SIL Open Font License.

Information for test institute

Energy labelling	
Australian standard	AS/NZS 2040:2021
Washing program	Normal, 40 °C, 9,5 kg cotton
Connection	Cold water 20 °C
Test method for noise measurement	IEC-60704-2-4
Power consumption in `off mode` (if applicable)	< 0,47 W
Power consumption in `end of cycle mode` (if applicable)	< 0,47 W
If delay start is available, power consumption in `delay start`	< 1,87 W
Power consumption in `time from end of program until end of cycle`	< 7,09 W
Remarks	Measurements were made at 230 V and 50 Hz

Loading procedure for standard test:

Detergent, PBIS and Anti-Sudsing Agent (18ml) must be added via the detergent compartment.

When loading the machine for testing according to AS/NZS 2040:2021 it shall be loaded according to the table below. Garments are placed on top of each other in layers and the soil swatches should be placed inside the wash drum in the direction shown in the table, seen from above.

	Top	Swatches	Swatch placement	Illustration of loaded Wash Drum for standard test.
38.	Bath towel	1	Front	<p>The diagram shows a circular wash drum with a vertical dashed line through the center. The drum is divided into 15 horizontal layers, numbered 1 to 15 from bottom to top. Swatches are placed on the following layers: 1 (Front), 2 (Right), 3 (Left), 4 (Rear), 29 (Rear), 30 (Front), 31 (Right), and 32 (Left). The top and bottom of the drum are labeled 'Top' and 'Bottom' respectively.</p>
37.	Pillow case	1	Left	
36.	Pillow case	1	Right	
35.	Sheet	1	Rear	
34.	Undershort	1	Center	
33.	T - shirt	1	Front	
32.	Bath towel	1	Left	
31.	Tablecloth	1	Right	
30.	Bath towel		Front	
29.	Shirt	1	Rear	
28.	Undershort	1	Center	
27.	T - shirt	1	Left	
26.	Undershort		Right	
25.	Pillow case	1	Front	

Technical information

	Top	Swatches	Swatch placement	Illustration of loaded Wash Drum for standard test.
24.	Sheet	1	Rear	<p>Top</p> <p>32</p> <p>31</p> <p>30</p> <p>29</p> <p>1</p> <p>4</p> <p>3</p> <p>2</p> <p>1</p> <p>Bottom</p>
23.	Wash cloths (all)		Center	
22.	Bath towel		Right	
21.	Shirt	1	Left	
20.	Undershirt	1	Front	
19.	Undershirt		Rear	
18.	Undershirt	1	Center	
17.	T - shirt	1	Left	
16.	Shirt	1	Right	
15.	Bath towel		Front	
14.	Handkerchiefs (all)		Center	
13.	Sheet	1	Rear	
12.	Pillow case	1	Left	
11.	T - shirt	1	Right	
10.	Undershirt	1	Center	
9.	Shirt	1	Front	
8.	Bath towel	1	Left	
7.	Tablecloth	1	Right	
6.	Bath towel		Rear	
5.	T - shirt	1	Left	
4.	Sheet	1	Right	
3.	Pillow case	1	Front	
2.	Pillow case	1	Rear	
1.	Bath towel	1	Center	
	Total	30		

Radio equipment type	
(depending on the model)	HL3215STG, HLW3215-TG, HLW3215-TG01
Wi-Fi	
Operating frequency range	2.4000 GHz – 2.4835 GHz
Maximum output power	≤10 dBm/MHz (EIRP) (Antenna gain <10 dBi)
Maximum antenna gain	Gain: 0 dBi
Bluetooth	
Operating frequency range	2.400 GHz – 2.4835 GHz
Carrier output	6 dBm (≤ 10 dBm)
Emission type	F1D

Declaration of conformity

The company declares that the device with the function **ConnectLife** complies with the essential requirements and other relevant provisions of Directive 2014/53/EU. The detailed Declaration of Conformity can be found at the web address <https://auid.connectlife.io> on the page of your device among the additional documents.

Wi-Fi Network Requirements and Recommendations

1. Access Point and Coverage

- Standard **2,4 GHz Band Wi-Fi network IEEE 802.11b/g/n** required,
- use a **stable router or access point** with adequate signal strength (minimum **-60 dBm**) at the appliance installation location,
- avoid excessive channel overlap; use non-overlapping 2,4 GHz channels (1, 6, or 11) and 20 MHz channel width,
- Wi-Fi network capacity must be dimensioned appropriately in multi-appliance installations.

2. Security and Encryption

- Network must use **WPA2-PSK (AES)** or WPA/WPA2 encryption,
- open (unencrypted) networks are not supported,
- appliance and mobile device must be connected to the **same SSID during initial setup**,
- continuous internet connection is required for operation of remote features.

3. Unsupported Network Types

- Networks with **captive portals** (browser-based login pages) or public Wi-Fi networks (hotel, guest hotspot with login, etc.),
- networks requiring **proxy servers or VPN tunnels**,
- networks with strict MAC filtering (unless appliance MAC is manually whitelisted),
- networks enforcing client-based default-deny access control (unless appliance is manually granted access).

Table of consumption values

Program		Temperature (°C)	Capacity (kg)	Programme duration (h:min) ¹	Energy consumption (kWh/cycle) ¹	Water consumption (l/cycle) ¹	Residual moisture content (%) ¹	Spin speed - default LCD (rpm) ¹
ii	Normal	20	9.5 FL	03:13	0.48	118	54	1600
	Normal*	40	9.5 FL	03:41	0.56	67	54	1600
iii	Normal	60	9.5 FL	03:40	2.20	114	54	1600
iv	Mix/Synthetics	30	4	02:34	0.50	50	38	1200
v	Time program	30	2	00:45	0.23	26	60	1400
vi	Normal	90	9.5 FL	03:41	2.16	121	54	1600

ii The 20°C program at the rated capacity for this program

iii One cotton program at the nominal temperature of 60°C or higher, at the nominal capacity for this program

iv One program for textiles other than cotton or a textile blend, at the nominal capacity for this program

v One program for quick washing of lightly soiled laundry, at the nominal capacity for this program

vi One program for heavily soiled textiles, at the nominal capacity for this program

¹ Due to the influence of water pressure, hardness, and inlet temperature, the type, quantity, and soiling of the laundry, the detergent used, power supply, and selected functions, the actual values may differ from the specified values.

FL Full load

* This program is for a normally soiled load at the rated capacity. This consumption data for the nominated energy labelling programme according to AS/NZS 2040.1 & AS/NZS 2040.2

Consumption data may vary from the given values depending on variations in water pressure, water hardness, water inlet temperature, room temperature, fluctuations in the electricity, type and volume of the laundry and any extra options.

Maximum or nominal load applies to laundry prepared pursuant to the IEC 60456 standard.

Adjustment of the displayed washing time

Advanced technology allows the appliance to sense the amount of laundry and add the required amount of water during the washing process. Depending on the washing load, washing time can be longer or shorter and the time displayed will be adjusted accordingly.

Moreover, displayed washing time may change due to differences in inlet water temperature. At low inlet water temperatures, washing time can be longer; at higher temperatures, it can be shorter.

Unevenly distributed laundry or lumps of laundry in the washing machine drum can cause problems such as vibration and noisy operation. The appliance can sense such lumps and will try to redistribute the laundry. Smaller loads (e.g. one towel, one sweater, one bathrobe etc.) or clothes made of materials with special geometrical properties are virtually impossible to distribute evenly across the washing machine drum (slippers, large items etc.). This results in several attempts to redistribute the laundry, which in turn leads to longer program duration.

Option table

Program	Default (T°C)	Washing mode (Mode)					Options						
		Default - Normal	(Eco) Green mode	Speed mode	Night mode	Intensive mode	Small load	Prewash	Super Rinse	High water level	Rinse and hold	Anti-crease	Delay start
Normal	40	✓	✓	✓	✓	✓	✓	✓	✓	✓	✓	✓	✓
White laundry	40	✓	✓	✓	✓	✓	✓	✓	✓	✓	✓	✓	✓
Coloured laundry	40	✓	✓	✓	✓	✓	✓	✓	✓	✓	✓	✓	✓
Mix/Synthetics	30	✓	✓	✓	✓		✓	✓	✓	✓	✓	✓	✓
Delicates	40	✓						✓	✓	✓	✓	✓	✓
Wool/Hand wash	30	✓		✓				✓	✓	✓	✓	✓	✓
Sportswear	40	✓		✓			✓	✓	✓	✓	✓	✓	✓
Outerwear	30	✓		✓			✓	✓	✓	✓	✓	✓	✓
Time program	30	✓								✓	✓	✓	✓
Jeans	40	✓	✓	✓		✓	✓	✓	✓	✓	✓	✓	✓
Shirts/Blouses	40	✓	✓	✓			✓	✓	✓	✓	✓	✓	✓
Bedding/Towels	40	✓	✓	✓	✓	✓	✓	✓	✓	✓	✓	✓	✓
Down	30	✓		✓			✓	✓	✓	✓	✓	✓	✓
Steam Refresh		✓											✓
Quick PRO	40	✓			✓		✓			✓	✓	✓	✓
Stain program	40	✓					✓		✓	✓	✓	✓	✓
Waterproofing		✓								✓			✓
Anti-allergy Cotton	60	✓			✓		✓		✓	✓	✓	✓	✓
Anti-allergy synthetics	60	✓					✓		✓	✓	✓	✓	✓
Textile trainers	cold	✓								✓	✓	✓	✓
Soft toys	40	✓		✓				✓	✓	✓	✓	✓	✓
Underwear	40	✓	✓	✓	✓	✓		✓	✓	✓	✓	✓	✓
Swimwear	30	✓	✓	✓					✓	✓	✓	✓	✓
Baby clothes cotton	40	✓	✓	✓	✓		✓		✓	✓	✓	✓	✓
Rinse		✓							✓	✓	✓	✓	✓
Spinning		✓									✓	✓	✓
Drain		✓											✓
Drum Cleaning		✓											✓

✓ Choice of options

cold Cold wash



Packaging is made of environmentally friendly materials that can be recycled, disposed of, or destroyed without any hazard to the environment. To this end, packaging materials are labelled appropriately.

The symbol on the product or its packaging indicates that the product should not be treated as normal household waste. Take the product to an authorized collection centre for waste electric and electronic equipment processing.

When **disposing** of the appliance at the end of its useful life, remove all power cords, and destroy the door latch and switch to prevent the door from locking or latching (child safety).

Correct **disposal** of the product will help prevent any negative effects on the environment and health of people, which could occur in case of incorrect product removal. For detailed information on removal and processing of the product, please contact the relevant municipal body in charge of waste management, your waste disposal service, or the store where you bought the product.



www.asko.com



946950-a7



We reserve the right to make changes.