

A	AZZII010109N						重要度	C	
							版本	A	
B	<p>1) 材质：70g双胶纸，钉装成型；</p> <p>2) 成型尺寸：140mm×210mm，空白页加在封底页；</p> <p>3) 印刷要求黑色印刷、印刷清晰；</p> <p>4) 制品应平整、无脏污及起皱破损，制件切边应整齐平滑；</p> <p>5) 其余要求应符合标准Q/HJ J04024《说明书》的相关规定；</p> <p>6) 有毒有害物质管控要求应符合Q/HJD J02169《厨卫产品有害化学物质含量规定》；</p> <p>7) 批量前需将墨稿及样品送至研发确认。</p>								
C									
D									
借(通)用件登记									
描图									
描校									
旧底图总号									
底图总号									
出图审查									
日期									
工艺									
					WD16-T729BXi		N6010101122V		
							20101641		
					安装使用说明书		阶段标记	重量	比例
					70g双胶纸		S A B	/	1:1
							共 / 张	第 / 张	
							海信(山东)厨卫有限公司		
1		2			3			4	

Hisense

life reimagined

USER'S OPERATION MANUAL

Before operating this unit, please read this manual thoroughly, and retain for future reference.

Dishwasher

HS9B16FB

EN

English

Contents

Your dishwasher	4
Safety instructions	5
Installation	6
Overflow guard function	6
Winter storage/transport	6
Packaging	7
Disposal	7
Before washing for the first time	8
Water hardness	8
Basic settings	8
Top up with rinse aid	8
Top up dishwasher detergent gel for automatic dosing	9
Greener dishwashing	10
Save energy and water	10
Loading the dishwasher	11
Fragile dishes	11
Loading affects the results	11
The dishwasher's baskets	11
Top cutlery tray	11
Upper basket	12
Lower basket	13
Using the dishwasher	15
Add detergent	15
Configuration before first use	16
On/Off	17
Select washing programs	18
Select option	20
Start a washing program	22
If you want to load more dishes	22
Power failure	22
Once the program has finished	23
The best drying results	23
Unloading the dishwasher	23
Program chart	24
WiFi connection	25
Settings	27
Care and cleaning	29
Top up with rinse aid	29
Top up dishwasher detergent gel for automatic dosing	29
Clean the filter	30
Cleaning the spray arms	31
Clean the outside of the dishwasher	32
CLn - Run the Self-clean program	32
Remove blockages	32

Troubleshooting	34
WiFi	39
Installation	40
Safety instructions	41
Transport protection for the door	41
Placing the dishwasher	41
Adjust the height and slide the dishwasher into place	42
Check the dishwasher's fan outlet is not blocked or covered	43
Drainage connection	43
Connection to water supply	44
Electrical connection	44
Remove dishwasher worktop	44
Service	45
Technical data and energy labelling	46
Information on energy label	46
Technical data	46
Information for consumers	46
Test standard	46

Your dishwasher

Install the dishwasher, see the chapter *Installation*. Press .

The first time the dishwasher is switched on, it is important that you choose the right settings to ensure good dishwashing results. See the chapter *Before washing for the first time*.

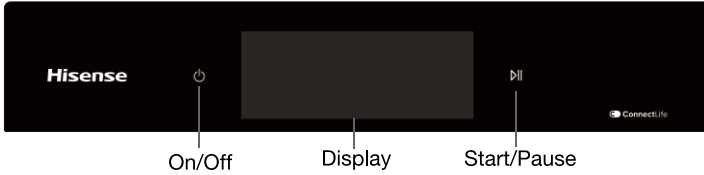

Display

On/Off

Display



Start/Pause







Program

Option

	Eco wash (3h40min)		Quick wash (30min)
	AI super wash		Self clean wash (1h5min)
	1 hour wash (1h)		Plastic wash (2h30min)
	Intensive wash (2h50min)		Rinse wash (7min)
	Glass wash (1h40min)		Device statistics
	Hygiene wash (1h5min)		

	Remote
	Child lock
	Mute

Information on the display

-  Top up with rinse aid
-  Top up dishwasher detergent for automatic dosing
-  Open or close the door
-  Weather
-  Connected to the cloud
- 12:00 Time

NOTE!

Touch the screen and swipe left and right to select the program. The above is a summary diagram, and the interface is subject to the actual display.

The control panel only reacts to use when the door is closed.

Safety instructions

- Read the operating instructions and keep them in a safe place!
- Number of standard place settings: 16
- Never use the dishwasher for any purpose other than that specified in these operating instructions.
- Do not load the dishwasher door or dishwasher baskets with anything other than dishes.
- The door should not be left in the open position since this could present a tripping hazard.
- Push the baskets in to avoid risking the dishwasher tripping over.
- Use only dishwasher detergent!
- This appliance can be used by children aged from 8 years and above and persons with reduced physical, sensory or mental capabilities or lack of experience and knowledge if they have been given supervision or instruction concerning use of the appliance in a safe way and understand the hazards involved. Children shall not play with the appliance. Cleaning and user maintenance shall not be made by children without supervision.
- This appliance is not intended for use by persons (including children) with reduced physical, sensory or mental capabilities, or lack of experience and knowledge, unless they have been given supervision or instruction concerning use of the appliance by a person responsible for their safety. Children should be supervised to ensure that they do not play with the appliance.
- If the supply cord is damaged, it must be replaced by the manufacturer, its service agent or similarly qualified person in order to avoid a hazard.
- Only use the dishwasher in household-type environments for dishwashing household dishes. All other use is prohibited.
- Never place dishes with solvent residues in the dishwasher due to the risk of explosion. Nor may dishes that contain ash, wax or lubricants be washed in the dishwasher.

- Children must be watched. Do not allow children to use or play with the dishwasher. Be especially vigilant when the door is open. Some detergent may remain inside! After adding detergent, always start the dishwasher immediately.

WARNING!

Knives and other utensils with sharp points must be loaded in the basket with their points down or placed in a horizontal position.

WARNING!

Children must be supervised—dishwasher detergent is corrosive!

WARNING!

Dishwasher detergents are strongly alkaline. They can be extremely dangerous if swallowed. Avoid contact with skin and eyes and keep children away from the dishwasher when the door is open. Seek medical attention if swallowed.

Check that the detergent compartment is empty after completion of the wash cycle.

Installation

See the chapter *Installation*.

Overflow guard function

The overflow guard starts pumping out the machine and turns off the water supply if the water level in the dishwasher exceeds the normal level. If the overflow guard is triggered, F54 (Overfilling water) appears on the display. Turn off the water tap and contact your nearest service centre. (To avoid water leakage outside the dishwasher, do not remove the plug from the wall socket until the water tap on the supply line has been turned off!)

Winter storage/transport

Store the dishwasher above freezing and avoid long transport distances in very cold weather. Transport the dishwasher upright or laying on its back.

Before transporting a used dishwasher, or before prolonged storage, water must first be removed from the machine.

Packaging

The outer packaging protects the product during transport. The packaging material is recyclable. Separate the different packaging materials to help reduce raw material use and waste. Your dealer can take the packaging for recycling or direct you to the nearest recycling centre. The packaging is comprised of:

- Corrugated cardboard made from up to 100% recycled material.
- Expanded polystyrene (EPS) with no added chlorine or fluorine.
- Supports made from untreated wood.
- Protective plastic made from polyethylene (PE).

Disposal

The dishwasher is manufactured and labelled for recycling. When the dishwasher has reached the end of its service life and is to be disposed of, it should immediately be made unusable. Pull out the power cable and cut it as short as possible.

Contact your local authority for information about where and how your dishwasher should be correctly recycled.



This symbol on the product or in its packing indicates that this product may not be treated as household waste. Instead, it should be taken to the appropriate waste collection point for the recycling of electrical and electronic equipment. By ensuring this product is disposed of correctly, you will help prevent potential negative consequences for the environment and human health, which could otherwise be caused by the inappropriate waste handling of this product. For more detailed information about the recycling of this product, please contact your local council your household waste disposal service, or the shop where you purchased the product.

Before washing for the first time

Water hardness

In order to achieve good dishwashing results, the dishwasher needs soft water (water with low mineral content). Hard water leaves a white coating on dishes and the dishwasher.

Checking water hardness

Contact the local water utility to check the water hardness in your area. This is important with regard to how much detergent and rinse aid to use.

Basic settings

The first time the dishwasher is switched on, it is important that you choose the right settings to ensure good dishwashing results. See the chapter *Settings*.

Set up:

- Rinse aid
- TAB
- Automatic dosing

✱ Top up with rinse aid

Drying is faster and a better result is achieved if you use rinse aid. You will also achieve a better dishwashing result with clear and spotless dishes.

Top up the rinse aid compartment with rinse aid if you have selected Rinse aid 01 - 05.

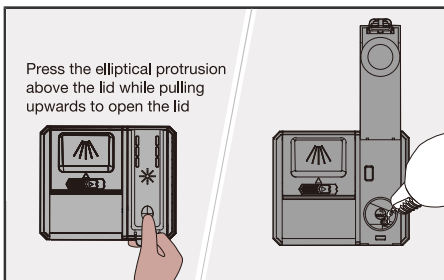

1. Open the rinse aid compartment lid.
2. Carefully top up with rinse aid to the level marked **MAX**.
3. Wipe up any splashes of rinse aid around the compartment.
4. Close the lid firmly.

For water with a hardness greater than 10–12 °dH, you ought to use rinse aid with citric acid (known as acid rinse aid).

Top up dishwasher detergent gel for automatic dosing

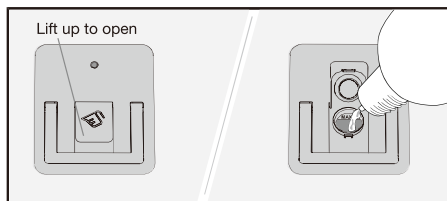

Fill the automatic dosing compartment with dishwasher detergent gel if you have activated the Automatic dosing of detergent setting.

1. Open the lid of the automatic dosing compartment for dishwasher detergent gel.
2. Carefully add dishwasher detergent gel to the level marked **MAX**.
3. Clean up any excess dishwasher detergent gel outside the compartment.
4. Close the lid firmly.

NOTE!

Use only dishwasher detergent gel in the automatic dosing compartment! Do not use dishwasher detergent powder. Washing up liquid must not be used as the foam that forms prevents the dishwasher from operating effectively.

Some thick dishwasher detergent gels are not suitable for the automatic dosing compartment. Add very thick dishwasher detergent gel into the manual detergent compartment. See the detergent manufacturer's recommendations.

Dishwasher detergent gel has a milder formula than dishwasher detergent powder or all-in-one detergent with bleaching agent. This means that dishwasher detergent gel may prove less effective at removing stains caused by, for example, lipstick and tea/coffee. If necessary, on such occasions dishwasher detergent powder or all-in-one detergent with bleaching agent can be added to the manual detergent compartment (when Automatic dosing of detergent is activated). See *Add detergent*.

When the dishwasher detergent gel needs topping up, the symbol  appears on the display. (You can run 1-2 wash programs before the compartment is completely empty.)

Dosing of dishwasher detergent gel

Dishwasher detergent gel is dispensed during the main wash for all programs. A little extra dishwasher detergent gel is also dispensed during the prewash in the following programs:

Auto

Intensive

Greener dishwashing

Save energy and water

When using a dishwasher in a residential setting, less energy and water are generally used compared to washing the dishes by hand.

Do not rinse under running water

Do not rinse the dishes under running water as this will lead to increased energy and water consumption. Simply scrape off large food particles before loading the dishwasher.

Choose a green detergent

Read the environmental declaration on the packaging!

Too much detergent and rinse aid can result in less effective dishwashing and also entail greater environmental impact.

Run a fully loaded dishwasher

Save energy and water by waiting until the dishwasher is full before running a program (see number of standard place settings). Use the *1h* program with the *Speed* wash option to rinse the dishes if there are any unpleasant odours.

Run programs at a lower temperature

If the dishes are only slightly dirty, you can select a program with a low temperature.

Select dishwashing program - Eco

This program is suitable for washing normally soiled dishes and is the most effective program in terms of combined energy and water consumption.

The dishwashing program is designed for an effective wash using as little energy and water as possible. The program washes at a low temperature for a long time.

Activate the setting – Smart dry

A shorter dishwashing program and better drying results are achieved if you activate the Auto Door Open setting, which automatically opens the dishwasher door. Wait until the dishwasher indicates that the program has ended and the dishes have cooled before unloading the dishwasher. (If the dishwasher is built-in, the surrounding furnishings must be resistant to any condensation from the dishwasher.)

WARNING!

The dishwasher door must not be blocked or closed when opened automatically. Doing so may damage the door lock mechanism. Wait at least 5 minutes before closing the door.

Connect to cold water

Connect the dishwasher to the cold water supply if the building is heated using oil, electricity or gas.

Connection to hot water supply

Connect the dishwasher to the hot water supply (max. 60 °C) if the building is heated using an energy-efficient means such as district heating, solar power or geothermal power. Choosing a hot water connection reduces the dishwasher's energy consumption.

NOTE!

Do not exceed the permitted water supply temperature. Certain materials used in some cookware cannot withstand high heat. See *Fragile dishes* in the chapter *Loading the dishwasher*.

Loading the dishwasher

Fragile dishes

Some cookware is not dishwasher safe. This can be for several reasons. Some materials cannot withstand high heat, others can be damaged by dishwasher detergent.

Exercise caution with, for example, handmade items, fragile decoration, crystal/glassware, silver, copper, tin, aluminium, wood and plastic. Look for the "Dishwasher safe" marking.

Loading affects the results

Load the dishes carefully to ensure the best washing and drying results with the lowest possible energy and water consumption. Give your dishwasher the best chance to reach and clean all surfaces, as well as to dry the dishes as thoroughly as possible.

- All dirty surfaces should face inwards and downwards!
- Dishes should not be placed in or on each other.
- Angle dishes with hollows, such as cups, so that the rinse water will run off. This is also important for plastic items.
- Make sure small items cannot fall through the dishwasher basket; place them in the top cutlery tray.



NOTE!

Check that the spray arms can rotate freely.

The dishwasher's baskets

The dishwasher is equipped with a top cutlery tray, an upper basket and a lower basket.

The appearance of the baskets may differ depending on the dishwasher setup.

Top cutlery tray

The top cutlery tray has space for cutlery, ladles, whisks, serving cutlery and similar items.

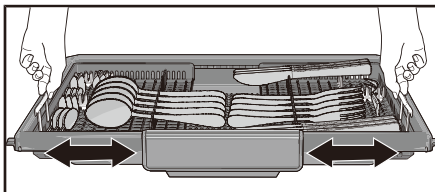
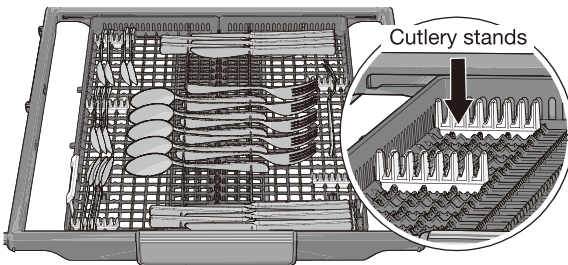

The top cutlery tray is comprised of three parts that can be moved sideways to better accommodate the dishes.

Upper basket

Place glasses, cups, bowls, side plates and saucers in the upper basket. All dirty surfaces should face inwards and downwards! Wine glasses are placed on the wine glass shelf and knives are placed in the knife stand on the right.

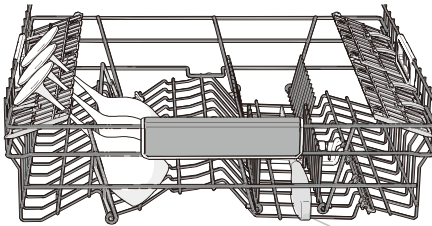
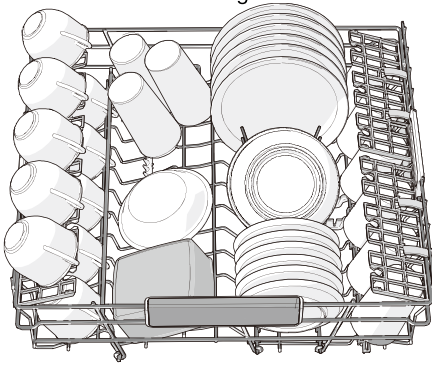

Knife stand

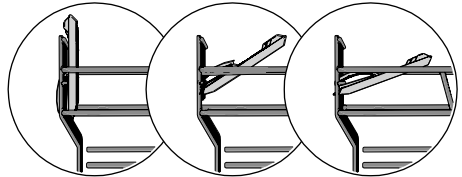

3 positions

Raising and lowering the upper basket

1. Pull out the upper basket.
2. Grab the sides of the upper basket with both hands and lift it up.
3. If the upper basket is raised while in the top position, it will drop to the bottom position.
Note that both sides of the basket must always be set to the same height.

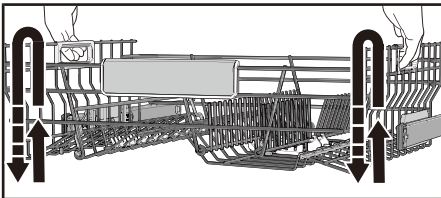

Adjustable plate supports

The adjustable plate supports can be folded down to make it easier to load pots, bowls and glasses.



Lower basket

Place plates, side plates, serving dishes and pots in the lower basket. Cutlery can be placed in the cutlery holder.

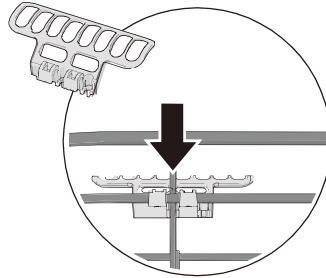
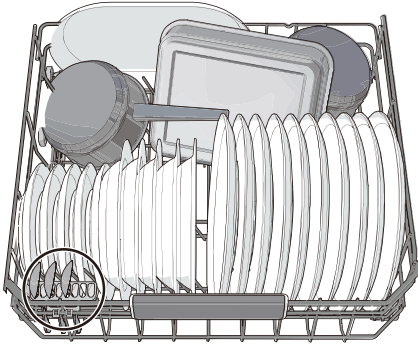

Fit the cutlery holder to achieve maximum loading capacity. (Found inside the enclosed plastic bag.)

Adjustable plate supports

The adjustable plate supports can be folded down to make it easier to load pots and bowls.

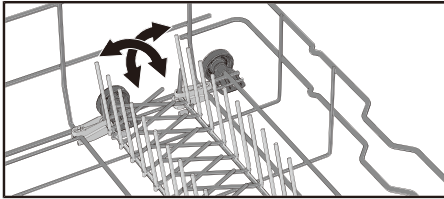

Tray holder

To clean the tray, raise both foldable holders and place the tray on the holders inclinely.

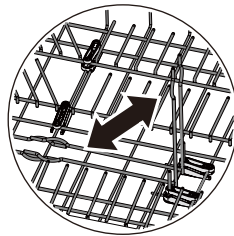
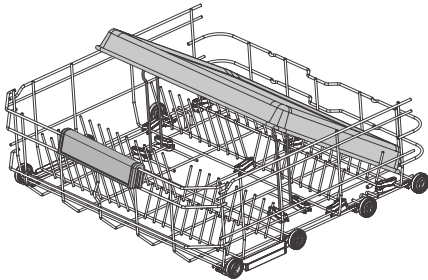

Bottle holder

To clean the bottle, raise both foldable holders and place the bottle on the holders inclinely.

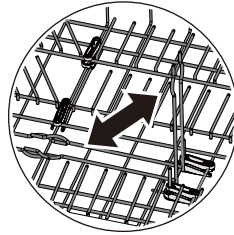
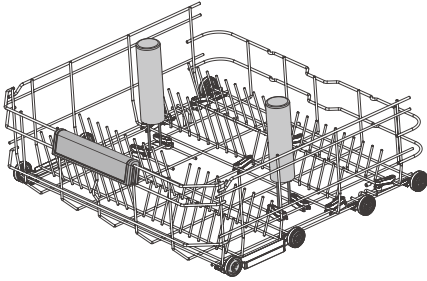

Cutlery basket

Place cutlery with the handles facing down, except for knives, and spread them out as much as possible. Ensure that spoons do not stack inside each other. Place the cutlery basket in the lower basket.

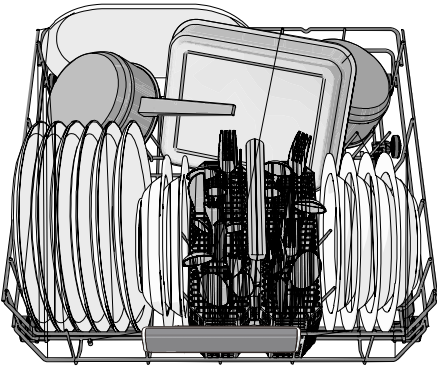

Cutlery basket with lid

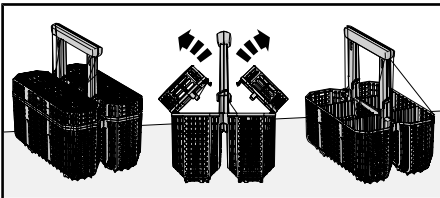

The cutlery basket lid can be removed.

Flexible cutlery basket

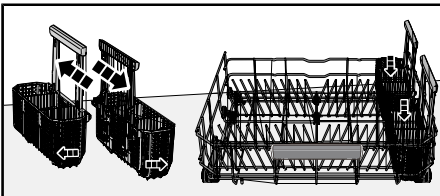

The cutlery basket is flexible and can be separated into two parts, which can then be attached to the side of the lower basket.

Using the dishwasher

Add detergent

Follow the instructions on the detergent packaging. And use detergent and rinse aid doses suitable for soft water.

Too much detergent can result in less effective dishwashing and also entails greater environmental impact.

Detergent compartment

The detergent compartment must be dry when adding detergent.

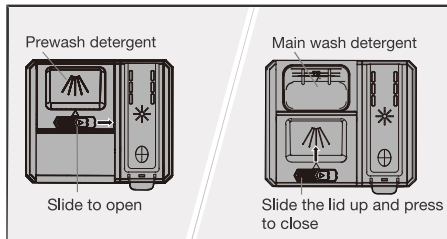

If powder or liquid dishwasher detergent is used, add a small amount of the detergent to the compartment for prewash detergent.

NOTE!

Use only dishwasher detergent! Washing up liquid must not be used as the foam that forms prevents the dishwasher from operating effectively.

All-in-one detergent

There are many types of all-in-one detergents on the market. Read through the directions for these products carefully.

Activate the TAB setting when using an all-in-one detergent that contains rinse aid.

Dishwasher tablets are not recommended for short programs (less than 75 minutes). Use powder or liquid dishwasher detergent instead.



NOTE!

Optimal washing and drying results are achieved by using normal detergent together with separately dispensed rinse aid and salt.

Contact the detergent manufacturer if you have questions about the detergent.

Configuration before first use

Before first use, configure the preferences of Language, Country And Region, Time Zone, User Agreement , Policy, Network, Time And Date according to the user's actual needs.



Language  

简体中文

English

Francais

NEXT



< Country And Region  

UK

Australia

South Africa

NEXT



< Time Zone  

GMT(London)

GMT-8(Pitcairn Islands)

GMT-5(Cayman Islands)

NEXT

< User Agreement  



CONNECTLIFE END USER LICENSE AGREEMENT
(Effective Date: March 1, 2023)

This End User License Agreement ("EULA") governs and regulates the use of the Application, Device and the Smart Services, and is a legal agreement between the end user (referred to as "you or your") and ConnectLife, LLC, and/or any company within the Hisense Group ("we" or "us" or "our" or "ours").

IF YOU WANT TO USE THIS APPLICATION

Agree to all terms

NEXT



< Policy  

DATA PROTECTION POLICY
(Effective Date: November 1, 2022)

Please read this Data Protection Policy (the "Data Protection Policy") carefully. By using the Application, installing and/or using and/or accessing the smart services through the Application, you agree to be legally bound and abide by this Data Protection Policy. The click on the "agree" locating at the bottom of this policy indicates that you have read and accepted this Data Protection Policy. By using the Application and/or the smart services,

Agree to all terms



NEXT

< Network  

Network >

WPS >

SKIP

< Time And Date  

23 59 30 05 2024
00^h 00^m 01^D 06^M 2025^Y
01 01 02 07 2026

NEXT



Display

On/Off

Display

Start/Pause

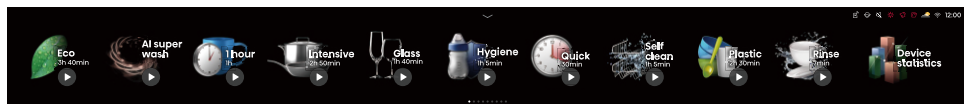

NOTE!



The control panel only reacts to use when the door is closed.

On/Off

Close the door properly, otherwise the dishwasher will not start. Press  for three seconds. Also turn on the water tap if it is turned off.

Press and hold  for three seconds to shut down the dishwasher.



Remote

You can swip down arrow  and then click the icon  to turn it on/off. The remote start switch is off by default, press and hold  to jump to the remote control settings page. You can choose to turn it on permanently. After enabled, the program can be started remotely through the APP.

Child lock

On the washing process page, you can choose to turn on the child lock function, click to turn it on, after turning on the child lock, the current screen and off-screen button operation does not respond, click any button or screen pop-up reminder, and press and hold for 3 seconds to cancel. If the child lock is opened when the door is closed, the child lock function will be retained after opening the door and closing the door again.

Mute

You can click the swip down arrow  and then click the icon  to turn it on. Mute switch, default off state. When enabled, there will be no audible feedback when tapping the screen or turning on or off.

Open or close the door

If the dishwasher is in the closed state, the icon does not appear, When the door was opened, the icon appears to remind the user to close the door

WARNING!

Please ensure that children stay away from the dishwasher while the fan on door is running.

Weather

When the dishwasher is connected to the Internet, the weather can be updated in real time.

12:00 Time

When the dishwasher is connected to the Internet, the time can be updated in real time.

Connect (WiFi)

You can remote control this dishwasher with your smartphone/tablet. Connect the dishwasher to your wireless network to be able to remote control and start the dishwasher using the *ConnectLife* app. See the chapter, *WiFi connection*.

Select washing programs

After turning on the machine by touching the power button, touch the program zone on the screen to select a proper program to suit the type of dishes and how dirty they are.



Eco wash (3h40min)

This program is suitable for washing normally soiled dishes and is the most effective program in terms of combined energy and water consumption. This program is used to assess compliance with EU legislation on ecodesign.

You can read more about greener dishwashing in the chapter *Greener dishwashing*.

For heavily soiled dishes with a lot of grease, a program with higher temperatures should be used.



AI super wash

This program is based on Auto upgrade, does not display the specific estimated time, the duration is displayed as Auto, which can automatically match the washing parameters and adjust the washing time according to the degree of dirtiness.



1hour wash (1h)

A quick program for slightly dried leftovers. (This program is not intended for burnt food, such as on oven dishes.)

The Smart Dry option is important for ensuring the best drying results.



Intensive wash (2h50min)

A program with a high temperature for dissolving grease on very dirty dishes, such as pans, casserole dishes and oven dishes. If these dishes do not completely fill the dishwasher, you can add plates and other dishes.



Glass wash (1h40min)

A gentle dishwashing program with a low temperature for washing fragile items made of crystal/glass. Remember to use a small amount of detergent and to place items so that they do not touch each other during the wash. See also *Fragile dishes* in the chapter *Loading the dishwasher*. Porcelain that has just been used without dried leftovers can also be washed using this program.



Hygiene wash (1h5min)

This program is ideal to use where demands on hygiene are extra high, e.g. for baby bottles and cutting boards. The temperature is high both in the main wash and in the final rinse.



Quick wash (30min)

A shorter wash for lightly soiled loads that do not need drying.



Self-clean wash (1h5min)

Self-cleaning program for hygienic cleaning of the dishwasher tub, spray arms and spray pipes.

This program should be run (with no dishes in the machine) using normal dishwasher detergent or citric acid. Special dishwasher cleaners are also available on the market. For the removal of limescale deposits, see *Dishwasher tub* in the chapter *Care and cleaning*.

The dishwasher will indicate at regular intervals that Self-clean needs to be run.



Plastic wash (2h30min)

A gentle dishwashing program with a low temperature for washing plastic items. Place items so that they do not touch each other during the wash.



Rinse wash (7min)

Used to rinse dishes while you wait for the dishwasher to become fully loaded.



Device statistics

Quickly access and analyze energy and water consumption statistics, with the ability to view historical data by week, month, or year, along with detailed program usage insights.

Start/Pause

Press  start or pause the program

Pausing or changing a program

Press  to pause the program.

Open the door and top up with new detergent if the lid of the detergent dispenser has opened. Close the door. Then select a new program and press .

Remaining time

Once you have chosen a program and options, the total time is displayed.

Select option

Press the options to activate them. (The available options vary between programs.)

You can change basic settings of most programs.

User may set the washing parameters and add additional functions as per need (before pressing the **Start/Pause** button).

NOTE!

Before starting a program, touch the parameters or functions to be set and turn ON/OFF the corresponding setting. A parameter/function is ON if the icon turns green.

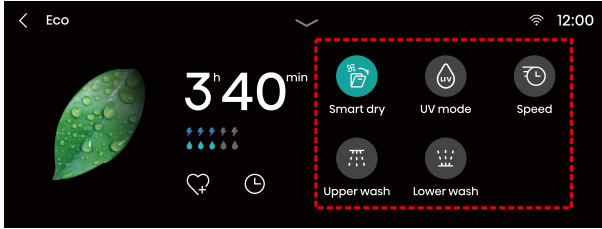

Smart Dry

The dishwasher door and fan dry open automatically, which improves drying results. Wait until the dishwasher indicates that the program has ended and the dishes have cooled before unloading the dishwasher. (If the dishwasher is built-in, surrounding furnishings must be resistant to any condensation from the dishwasher.)

Press  to activate the option, which is indicated by an indicator green light.

Not available for: Hygiene, Self-Clean, Rinse.

UV mode

Add the UV sterilization function, which can deeply remove the residual bacteria on the surface of the bowls.

Not available for: Quick, Rinse.

Speed wash

This option shortens the program time, but uses more energy and water.

Touch the icon activate the option.

Not available for: AI wash, Glass, Hygiene, Quick, Self-Clean, Plastic, Rinse.

Upper Wash

When you select Upper Wash, only the upper spray arm is activated. The lower spray arm will not operate.

Not available for: AI wash, Self-Clean.

Lower Wash

When you select Lower Wash, only the lower spray arm is activated. The upper spray arm will not operate.

Not available for: AI wash, Self-Clean.

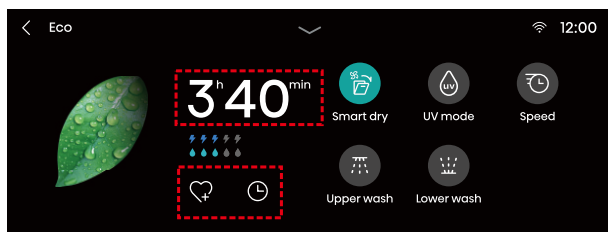

340™ 3h40min

Indicating the washing time, which is the standard washing time of this program and cannot be adjusted.

♥ Favorites

Touch this icon to add the current program to your favorites. The added program will appear at the top of the program list so that it can be selected with priority during next use.

🕒 Delay

Delay can be made after selecting the program and function. After touching the icon, enter the Delay interface. The time is the end time of the program, including the running time of the entire program, so it must be longer than the running time.

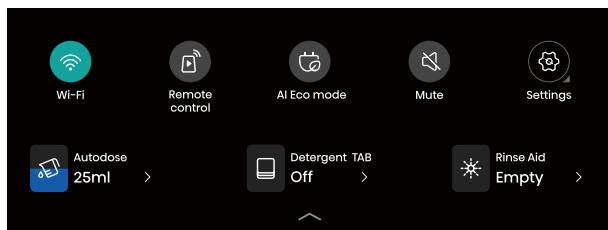
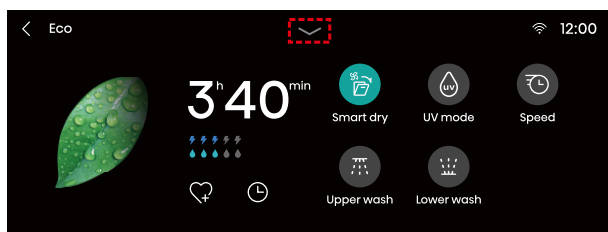

⌵ Setting Options:

After swiping down the settings icon ⌵, a drop-down list of setting options will appear, for setting WLAN, Remote Control, AI Eco mode, Mute, Settings, Autodose, Detergent TAB, Rinse aid.

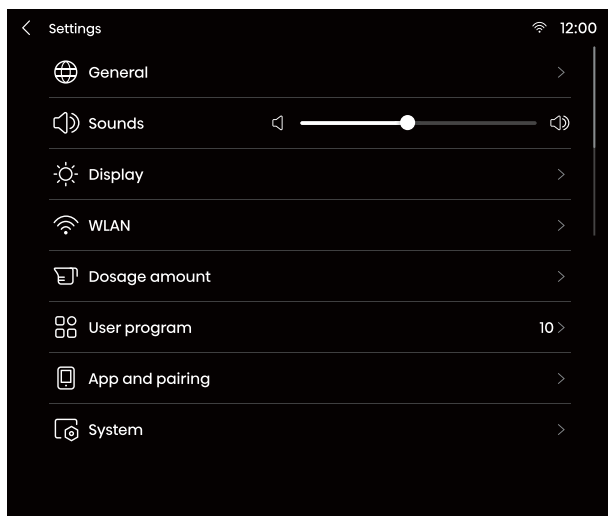

Settings

This function allows you to enter the System Settings interface, where you can set General, Sounds, Display, WLAN, Dosage amount, User Program, APP and Pairing, and System.

Start a washing program

After selecting a program and its function parameters, touch the **Start/Pause** button to start washing.

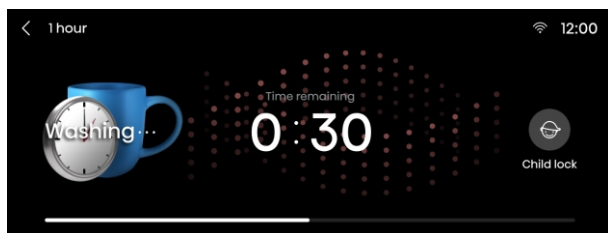

When the program is running, the screen will display the remaining time and other relevant information.

If you want to load more dishes ¹⁾

Press **⏸** to pause the program. Open the door. Add the dishes and close the door. Then press **▶** to continue washing.

Power failure

If the dishwasher is turned off due to a power failure when a dishwashing program is running, the program continues when power is restored. If the power is cut during drying, the program is interrupted.

¹⁾ You should not load more dishes if the lid of the detergent dispenser has been opened.

Once the program has finished

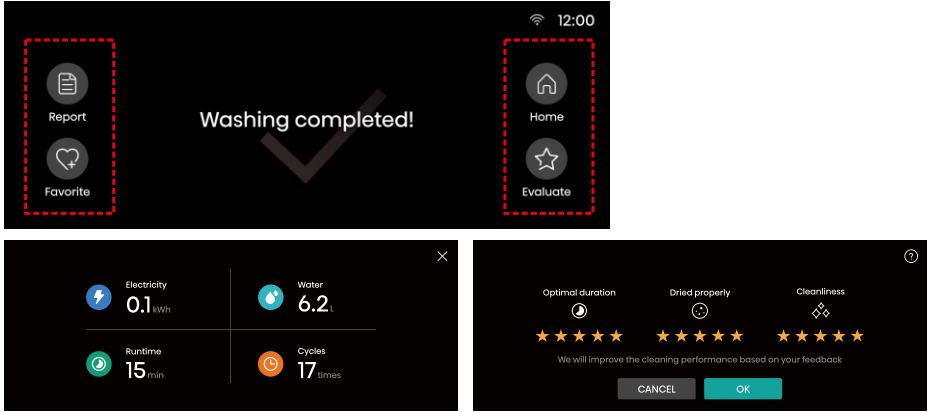

Once the program has finished, "Washing completed" appears on the display. And the dishwasher turns off after 3 minutes and this parameter can be set.

Report: Click it to view the Energy Used, Water Consumption, Time and Rinse Cycles of this washing.

Favorites: Click it to add the program and settings of function parameters of this dishwasher to your favorites. The added program will appear at the top of the program list. so that it can be selected with priority during next use.

Home: Click it to go back to the home screen for the next program.

Evaluate: User can evaluate the star level of this dishwasher to help us in continuous.

The dishwasher switches off automatically after the program ends. Shut off the water tap after each use.

The best drying results











- Fully load the dishwasher.
- Angle dishes with hollows, such as cups, so that the rinse water will run off. This is also important for plastic items.
- Top up with rinse aid or increase the rinse aid dosage setting.
- Activate the Auto door open setting. See the chapter *Using the dishwasher*.
- Allow the dishes to cool before unloading the dishwasher.

Unloading the dishwasher

Hot porcelain is more fragile. Leave the dishes to cool in the dishwasher before unloading them.

Unload the lower basket first to avoid any water drops from the upper basket falling onto the dishes in the lower basket.

Program chart

Program	Detergent (g)	Number of pre-washes	Main wash	Number of rinses	Final rinse	Consumption values ¹⁾		
						Dishwashing time (approx. hrs:min)	Energy (approx. kWh)	Water cons. (liter)
 AI super wash	25	1-2	40-65 °C	2-3	60 °C	1:47-3:10	0.7-1.4	9.0-19.0
 1h wash	25		65 °C	3	65 °C	1:00	1.1	13.0
 Intensive wash	25	2	70 °C	2	70 °C	2:50	1.5	15.5
 Eco wash	24	1	44 °C ²⁾	2	39 °C	3:40	0.59	10.6
 Plastic wash	25		47 °C	2	50 °C	2:30	0.54	10.0
 Glass wash	20		40 °C	2	50 °C	1:40	0.6	10.0
 Hygiene wash	25		70 °C	2	72 °C	1:05	1.1	9.5
 Self clean wash	25		70 °C	3	70 °C	1:05	1.2	10.0
 Quick wash	/		40 °C	2	40°C	0:30	0.36	6.6
 Rinse wash	/		/	1	/	0:07	0.01	3

1) Consumption values vary depending on the temperature of the incoming water, room temperature, load size, selected additional functions and more. The consumption values for the Eco wash program are accurate, others are indicative only.

2) The program Eco wash is recommended for a normally soiled load equal to the rated capacity of the dishwasher.

WiFi connection

ConnectLife

You can remote control this dishwasher with your smartphone/tablet. Connect the dishwasher to your wireless network to be able to remote control and start the dishwasher using the *ConnectLife* app. The app can be used to find information, change settings, start a program and monitor the dishwasher. (The dishwasher can always be used without the app.)

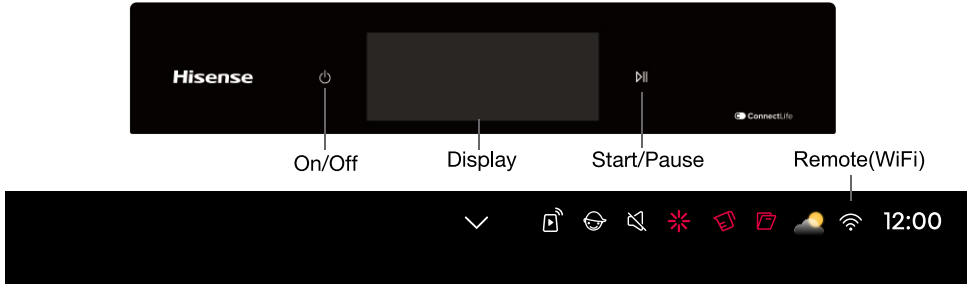

Preparations

- Your smartphone/tablet must be connected to the internet.
- The router in your wireless network must be connected to the internet and the dishwasher must be in range of your wireless network.
- Use your smartphone/tablet to download the *ConnectLife* app from the appropriate app store or scan the QR code below. If you do not have account, please create one.



- You will find the dishwasher serial number on the Rating Plate.



WiFi Connect to a network

- Turn on the machine after connecting it to power supply.
- Swiping down the ∨ and then long press “Wi-Fi” to enter the network connection configuration interface. You can select either “Wi-Fi” or “WPS” to connect the machine to network.

Select network for network connection

- Click “network” and set network to ON, and wait for the machine to search the available networks;

- Select the network to be connected; enter the password, and click “JOIN”;
- When the network is connected successfully, “√” will appear on the left side of the network name.
- Otherwise, please reselect the network and enter the correct password, or select another network connection mode;

Select “WPS” for network connection

- Click “WPS”; after a prompt appears, click the “WPS” switch on the router to confirm that the machine is connected to network; follow *Binding* to bind the machine.

Binding

- Click “Settings” at the upper right corner to enter the Settings interface;
- Click “App and Pairing” to enter the binding interface;
- Click “Bind A New Account” to enter the new user binding process;
- Click “Next” and use the phone to scan the special QR code for binding to bind the machine.

Remote control the dishwasher

Click the remote control switch button in the drop-down bar, and the remote control is turned off by default.



You can also choose to start the program remotely permanently. Press and hold the icon , select “Remote control level”, and then choose the “Permanent Remote start”. When selected, the remote control switch button in the drop-down bar is enabled by default.

You can use ConnectLife app to monitor the dishwasher and change settings.

Remote start the dishwasher

In the *ConnectLife* app, select and start a program. The remaining time will appear on the dishwasher display when a program is remote started.

Settings

1. Press  and close the door.
2. To open the dishwasher's settings menu, swiping down the sign .
3. Press “Settings” to step through the setting menu.
4. Confirm the selected setting by clicking the corresponding parameter.
5. To exit the menu, clicking the sign .

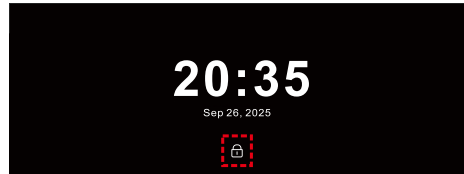
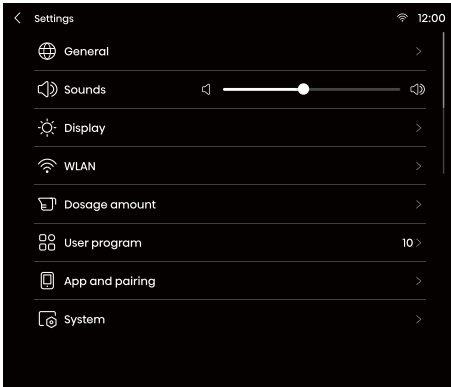
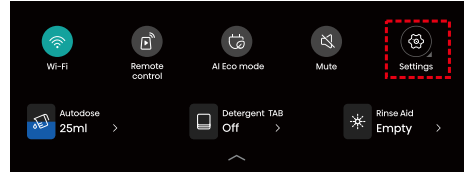
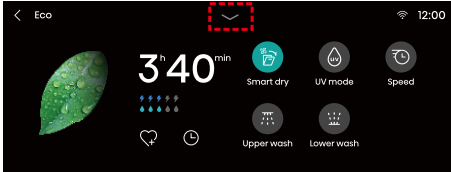

Settings		Illustrations
1	General	You can set the “Language”, “Weather Service”, “Time zone”, “Date And Time”, “Date Format”.
2	Sounds	The user can slide to adjust the sound of the device, from left to right, increase it in order (value 0~100, step size is 10), and swipe to the leftmost end to turn off the sound effect
3	Display	Brightness adjustment: the user can slide to adjust the brightness of the screen, from left to right, the brightness becomes brighter (brightness value 0~100, step size is 10). Set the screen off and select the automatic screen off time: 1 min, 5 min, 15 min, 30 min, and 60 min. You can tap anywhere on the screen to wake up again. Screen lock settings: select the automatic lock screen time, and enter the lock screen after the screen is stuck for a long time: 1min, 5min, 15min, 30min, 60min, and Always on. You can press and hold  for 3 seconds to cancel screen lock.
4	Dosage amount	Rinse aid:press the “Dosage amount”, you can set the “Rinse aid” parameter. Standard dispensing options: 0, 1, 2, 3, 4, 5. If there is excessive water remaining on the dishes, increase the rinse aid setting. If you notice white or blue residues, decrease the setting.

Settings		Illustrations
4	Dosage amount	Press the “Dosage amount”, you can set the “Autodose” parameter. The standard volume options: off, 15, 20, 25, 30, 35, 40ml. When the auto dose function is enabled, set the amount of detergent dispensed each time.
5	System	Pressing the “System”, you can restore all settings to the factory defaults. Select “Reset” and press “sure”.
6	User program	Selecting at least one washing program, and the selected program will be displayed directly on the main page.
7	Detergent TAB	Swiping down the sign ∨ , you can set detergent TAB. Activate this setting when using an all-in-one detergent that contains rinse aid. This setting reduces the rinse aid dosage and affects how often the dishwasher’s built-in softener is regenerated. Pre-selected at factory:off.
End	Exit	To exit the menu, clicking the sign < .

Care and cleaning

✱ Top up with rinse aid

When the rinse aid needs topping up, the above symbol lights on the display.

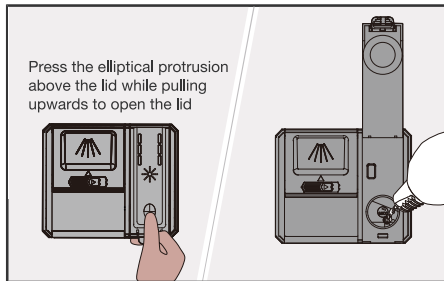

1. Open the rinse aid compartment lid.
2. Carefully top up with rinse aid to the level marked **MAX**.
3. Wipe up any splashes of rinse aid around the compartment.
4. Close the lid firmly.

After topping up, it may take a while before the symbol goes out.

💡 NOTE!

For water with a hardness greater than 10-12 °dH, you ought to use rinse aid with citric acid (known as acid rinse aid).

🗑️ Top up dishwasher detergent gel for automatic dosing

When the dishwasher detergent gel has run out and needs to be refilled, the above symbol appears on the display. (You can run 1-2 programs before the compartment is completely empty.)

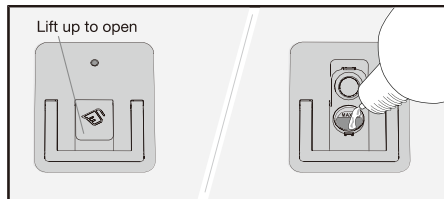

1. Open the lid of the automatic dosing compartment for dishwasher detergent gel.
2. Carefully add dishwasher detergent gel to the level marked **MAX**.
3. Clean up any excess dishwasher detergent gel outside the compartment.
4. Close the lid firmly.

After topping up, it may take a while before the symbol goes out.

💡 NOTE!

Use only dishwasher detergent gel in the automatic dosing compartment! Do not use dishwasher detergent powder. Washing up liquid must not be used as the foam that forms prevents the dishwasher from operating effectively.

NOTE!

Some thick dishwasher detergent gels are not suitable for the automatic dosing compartment. Add very thick dishwasher detergent gel into the manual detergent compartment. See the detergent manufacturer's recommendations.

Clean the automatic dosing compartment

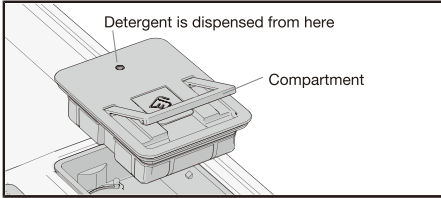

1. The compartment can be lifted out for cleaning and refilling.
2. Check that the dispensing hole is not blocked. Clean the compartment with hot water.

NOTE!

Important - refit the compartment. The dishwasher must not be used without the automatic dosing compartment in place!

Normally, a small amount of dishwasher detergent will leak out when lifting out the compartment.

Clean the filter

The filter traps larger food particles, which cannot get past the drainage pump. Empty the filter when necessary. It should be cleaned at regular intervals depending on how often the dishwasher is used.

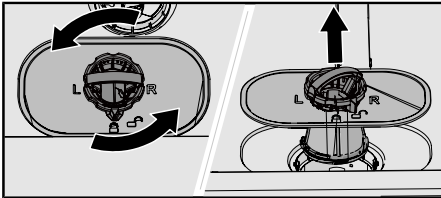

1. Turn the locking ring anticlockwise and lift the filter straight up.
2. Empty and clean the filter.
3. Refit the filter and turn the locking ring clockwise to its stop position. Check that the edges seal properly.

NOTE!

Dishwashing results may be affected if the filter is fitted incorrectly. The dishwasher must not be used without the filter in place!

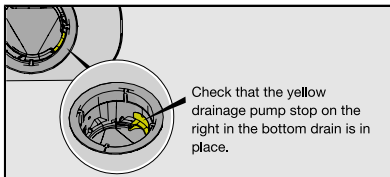

Check that the yellow drainage pump stop on the right in the bottom drain is in place.

Cleaning the spray arms

Holes and bearings can sometimes become blocked. Remove any debris using a pin or the like. The spray arms also have holes underneath.

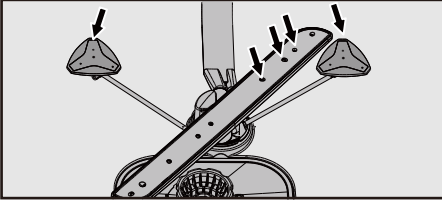

To facilitate cleaning you can remove the spray arms. Remember to fit them firmly back into place afterwards.

Top spray arm

- Pull out the top cutlery tray. Unscrew the top spray arm bearings anticlockwise to remove the spray arm.

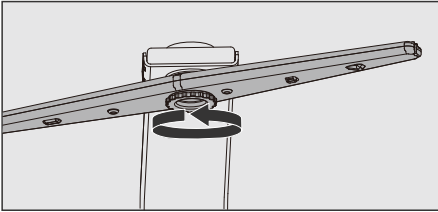

Upper spray arm

- Pull out the upper basket.
- Unscrew the spray arm bearings anticlockwise to remove the spray arm from the upper basket.

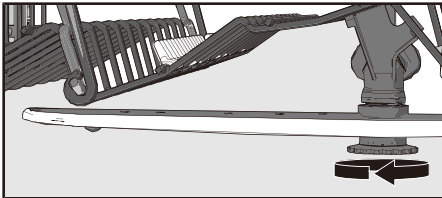

Lower spray arm

- Pull the lower spray arm straight up to release it.

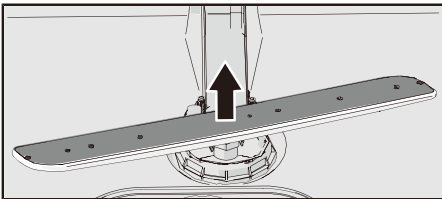

Corner boost spray arm

- Press and hold the metal tube, then pull the corner boost spray arm straight up to release it. (Before pulling up the spray arm, the metal tube must be held, otherwise it will cause deformation of the metal tube.)

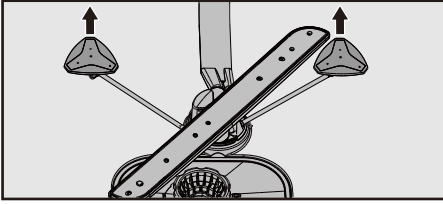

NOTE!

If the dishes are misplaced, the rotation of corner boost might be obstructed, or even blocked.

Clean the outside of the dishwasher

Door and door seal

Open the door. Clean the sides of the door and the door seal regularly with a slightly damp cloth. Clean the door seal at the lower front edge of the dishwasher with a washing-up brush.

Control panel

Keep the control panel clean. If necessary, wipe it with a dry or slightly damp cloth. Never use cleaning products – they may scratch the surface.

CLn - Run the Clean(Self-clean) program

Dishwasher tub

The dishwasher tub is made of stainless steel and is kept clean through normal use (when used regularly).

If you have hard water, limescale deposits may build up in the dishwasher. If this happens, run Self-clean with two tablespoons of citric acid in the detergent compartment (with no dishes in the machine). Special dishwasher cleaners are also available on the market.

Remove blockages

Unblocking the drainage pump

If the dishwasher still contains water after the program has finished, something may be blocking the drainage pump, which results in the Water outlet fault error message.

1. Turn off the machine using  and remove the plug from the wall socket.
2. Remove the filter.
3. Scoop out the water from the dishwasher tub.
4. In order to inspect the drainage pump, remove the yellow drainage pump stop on the right in the bottom drain. (Use a pair of pliers if necessary.)
5. Turn the pump wheel located behind the drainage pump stop by hand. Carefully remove any sharp items, such as glass.
6. Refit the drainage pump stop. Refit the filter.
7. Plug the machine in again.

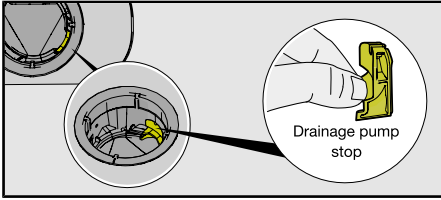

 **NOTE!**

Do not forget to refit the drainage pump stop.

Unblocking the inlet hose filter

If the water supply contains small particles, the outer filter on the inlet hose may become blocked, which results in the Water inlet fault error message.

1. Turn off the machine using  and remove the plug from the wall socket.
2. Turn off the water tap.
3. Unscrew the inlet hose.
4. Carefully remove the outer filter from the inlet hose and clean it.
5. Refit the filter and check that the gasket is correctly positioned.
6. Screw the inlet hose firmly into place.
7. Plug the machine into the wall socket and turn on the water tap. Allow the pressure to settle for a while and check that the connection is watertight.

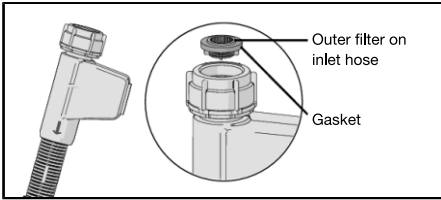

Troubleshooting

Error messages		Action
F11	Water outlet fault	See <i>Water remains in the dishwasher</i> in the table <i>Problem</i> below. If the problem persists, contact your nearest service centre.
F12	Water inlet fault	Check that the water tap is on. Check that the outer filter on the inlet hose is not blocked. See <i>Unblocking the inlet hose filter</i> in the chapter <i>Care and cleaning</i> . If the problem persists, contact your nearest service centre.
F40	Inlet valve leakage	Turn off the water tap and contact your nearest service centre.
F41	Heater fault	Turn off the water tap. Remove the plug from the wall socket and contact your nearest service centre.
F42	Temperature sensor fault	Turn off the water tap and contact your nearest service centre.
F43	Water level fault	Turn off the water tap and contact your nearest service centre.
F45	Diverter fault	Contact your nearest service centre.
F54	Overfilling water	Turn off the water tap and contact your nearest service centre. To avoid water leakage outside the dishwasher, do not remove the plug from the wall socket until the water tap on the supply line has been turned off!
F56	Circulation fault	Turn off the water tap and contact your nearest service center.
F65	Communication fault	Contact your nearest service centre.

Press  to clear the error message except for F54. After the dishwasher appears F54 error, it can only be turned off when there no overflow signal was detected.

Problem	Possible causes	Action
The control panel does not react when pressed.	You have pressed the control panel too soon after closing the door.	Wait a moment then try again.
	The door is open.	The control panel only reacts to use when the door is closed.
	Child lock or Automatic child lock is activated.	See the chapter <i>Using the dishwasher</i> .
	Dirt on the control panel.	Clean with a dry or slightly damp cloth.
Cannot close door.	The baskets are not correctly positioned.	Check that the baskets are correctly positioned horizontally.
		Check that the dishes are not blocking the baskets from sliding properly into place.

Problem	Possible cause	Action
The dishwasher does not start.	▶ has not been pressed.	Press ▶ . The display starts counting down.
	The door is not properly closed.	Check.
	You have opened the dishwasher to add more dishes while a program is in progress.	Close the door and press ▶ .
	Check whether the Delay start option has been selected.	Press and hold ▶ for three seconds if you want to cancel the Delay start option.
	The plug is not plugged into the wall socket.	Check.
	A fuse/circuit breaker has been tripped.	Check.
The dishes are not clean.	The spray arms do not rotate.	Check that the dishes are not blocking the spray arms.
	Spray arm holes or bearings blocked.	Clean the spray arms. See the chapter <i>Care and cleaning</i> .
	Unsuitable dishwashing program.	Select a program with a high temperature to dissolve grease on very dirty dishes, such as Intensive.
	Incorrect detergent dosage.	Dose according to water hardness. Far too much or far too little detergent results in poorer dishwashing results.
	Old detergent. Detergent is a perishable product.	Avoid large packages.

Problem	Possible causes	Action
	Dishes loaded incorrectly.	Do not cover porcelain with large bowls or the like. Avoid placing very tall glasses in the corners of the baskets. See the chapter <i>Loading the dishwasher</i> .
	Glasses and cups have toppled over during the program.	Place dishes to sit steady.
	The filter is clogged.	Clean the filter.
	The filter is not fitted correctly.	Check that the filter is fitted correctly. See the chapter <i>Care and cleaning</i> .
	Drainage pump stop missing.	Check that the yellow drainage pump stop on the right in the bottom drain is in place. See the chapter <i>Care and cleaning</i> .
Spots on stainless steel or silver.	Some foodstuffs, such as mustard, mayonnaise, lemon, vinegar, salt and dressings, can cause spots on stainless steel if left for too long.	Rinse off these types of foodstuffs if not starting the dishwasher immediately. Consider using 1h with the Faster option.
	All stainless steel can cause spots on silver if they come into contact during dishwashing. Aluminium can also cause spots on dishes.	In order to avoid marks and tarnishing, separate dishes made from different metals, such as silver, stainless steel and aluminium.
Spots or films on the dishes.	Incorrect rinse aid dosage setting.	See the chapter <i>Settings</i> .
	The setting TAB is activated and all-in-one detergent with insufficient drying effect is being used.	Switch all-in-one detergents or deactivate the TAB setting and top up with salt and separate rinse aid. See <i>Rinse aid</i> in the chapter <i>Settings</i> .
	Too high temperature and/or too much detergent can cause etching on crystal. Unfortunately, this cannot be repaired, only prevented.	Wash crystal at a low temperature and with a conservative amount of detergent. Contact the detergent manufacturer.
The dishes have a sticky white/blue film.	Rinse aid dosage setting too high.	Reduce the dosage. See the chapter <i>Settings</i> . If you have very soft water, you may want to dilute the rinse aid 50:50 with water.
Spots left after washing.	Lipstick and tea can be difficult to wash off.	Use a detergent with a bleaching agent. The detergent compartment

Problem	Possible causes	Action
Detergent residue in the detergent compartment after dishwashing.	The detergent compartment was damp when adding detergent.	The detergent compartment must be dry when adding detergent.
	The detergent compartment has been blocked.	Check that the dishes are not preventing the detergent compartment from opening.
Rattling sound when dishwashing.	The dishes are not correctly placed or the spray arms are not rotating.	Check that the dishes are placed securely. Spin the spray arms to make sure they can rotate.
Water remains in the dishwasher.	The filter is clogged.	Clean the filter.
	The filter is not fitted correctly.	Check that the filter is fitted correctly. See the chapter <i>Care and cleaning</i> .
	Debris in the drainage pump.	Clean the drainage pump. See the chapter <i>Care and cleaning</i> .
	Drainage pump stop missing.	Check that the yellow drainage pump stop on the right in the bottom drain is in place. See the chapter <i>Care and cleaning</i> .
	Kink in drainage hose.	Check that the hose is free from kinks and sharp bends.
	Blocked drainage hose.	Disconnect the drainage hose where it connects to the sink unit's water trap. Check that no debris has fastened and that the connection has an inner diameter of at least 14 mm.
Bad odour in dishwasher.	Dirt around the seals and in corners.	Clean with washing-up brush and low foaming cleaner.
	Low temperature programs have been selected for a prolonged period.	Run a program with a high temperature once or twice a month. Or run a self-cleaning program. See <i>Self-clean</i> in the chapter <i>Using the dishwasher</i> .
Grease deposits in the dishwasher.	Low temperature programs have been selected for a prolonged period.	Select a program with a high temperature to dissolve grease on very dirty dishes, such as <i>Intensive</i> . Or run a self-cleaning program. See <i>Self-clean</i> in the chapter <i>Using the dishwasher</i> .

Problem	Possible causes	Action
The dishes are not dry enough.	The Auto door open setting has not been activated.	Activate the Smart Dry option.
	The dishwasher is not fully loaded.	Fully load the dishwasher.
	Rinse aid needs topping up or dosage is set too low.	Top up with rinse aid or increase the rinse aid dosage setting.
	The setting TAB is activated and all-in-one detergent with insufficient drying effect is being used.	Switch all-in-one detergents or deactivate the TAB setting and top up with salt and separate rinse aid. See <i>Rinse aid</i> in the chapter <i>Settings</i> .
Water appeared near the outlet of the dishwasher's fan.	When the dishwasher's fan is running, a small amount of water vapor will condense near the outlet.	This is a normal phenomenon. Please rest assured to use it.
	A large area of flowing water had accumulated on the floor near the dishwasher's fan outlet.	Contact your nearest service centre.

WiFi

Problem	Possible causes	Action
The dishwasher's network symbol  does not appear on the display.	The dishwasher is not connected to your wireless network.	Connect the dishwasher to your wireless network. See the chapter, <i>WiFi connection</i> .
	The WiFi connection is deactivated.	Activate the WiFi connection. See <i>Deactivate/activate WiFi connection</i> in the chapter, <i>WiFi connection</i> .
WiFi connection failed.	The dishwasher cannot access your wireless network. Or the router is not connected to the internet.	Check that the router is connected to the internet.
		Make sure your wireless network is using 2.4 GHz and is visible. Try moving the router closer to the dishwasher if the signal is too weak.
		See also troubleshooting at www.connectlife.io/help-support . If the problem persists, contact your nearest service centre.
Pairing failed.	The dishwasher cannot access your wireless network. Or the router is not connected to the internet.	Check that the router is connected to the internet.
		Check that your smartphone/tablet is connected to your wireless network.
		See also troubleshooting at www.connectlife.io/help-support . If the problem persists, contact your nearest service centre.
The dishwasher is shown as disconnected in the <i>ConnectLife app</i> .	The WiFi connection is deactivated.	Activate the WiFi connection. See <i>Deactivate/activate WiFi connection</i> in the chapter, <i>WiFi connection</i> .
		See also troubleshooting at www.connectlife.io/help-support . If the problem persists, contact your nearest service centre.
Software update failed.	The network connection was lost or the dishwasher lost power due to a power failure.	Make sure that the power supply is not interrupted and that the network connection is stable before trying again. If the problem persists, contact your nearest service centre.

Installation

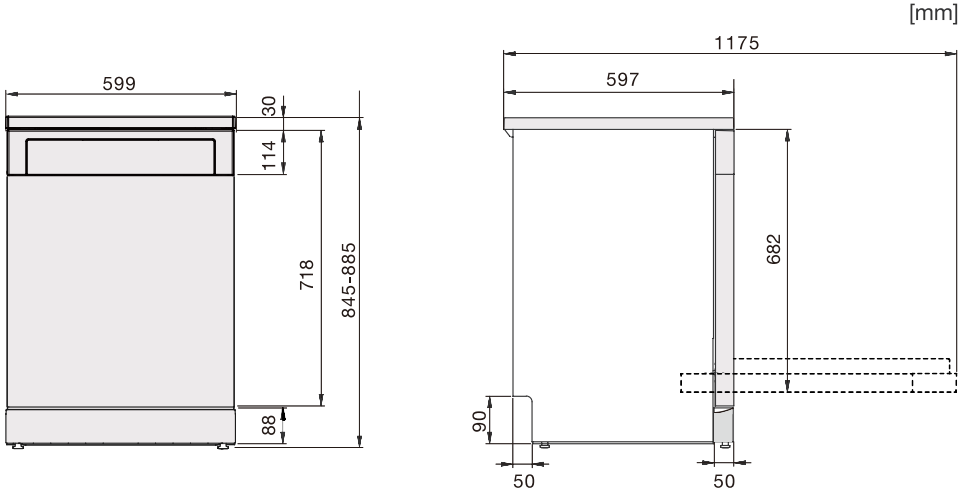

Location	Size/mm
Dimensions of space (W*D*H)	599*597*(845~885)
The height of the door	718
The height of control panel	114
The height of the table top assy	30
The size of the plinth (D*H)	50*88
Avoidance dimensions at the rear of the base (D*H)	50*90
The maximum depth of the whole machine after opening the door	1175
The height of the hinged door to the countertop frame	682

Nominal dimensions. Actual measurements may vary.

Safety instructions

- Connections to electricity, water and drainage must be performed by a qualified professional.
- Always follow applicable regulations for water, drainage and electricity.
- Take care during installation! Wear protective gloves! There must always be two people!
- Place a drip tray on the floor beneath the dishwasher to prevent damage from any water leaks.
- Before screwing the dishwasher into place, test the dishwasher by running the 1h program with the Faster option. Check that the dishwasher fills with water and drains. Check also that none of the connections leak.

WARNING!

Turn off the water supply when installing the dishwasher!

The plug must be disconnected or power to the socket turned off while the work is carried out!

Transport protection for the door

Do not forget to remove the transport protection for the door when unpacking the dishwasher.

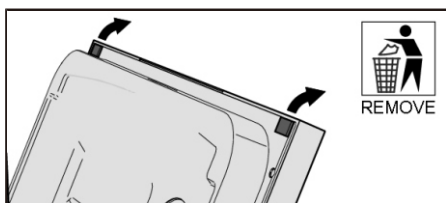

Placing the dishwasher

The dishwasher can be installed under a worktop or freestanding. Make sure the area on which the dishwasher is to be installed is firm.

- When the dishwasher is installed with its worktop, the build-in measurements are shown in the illustration.

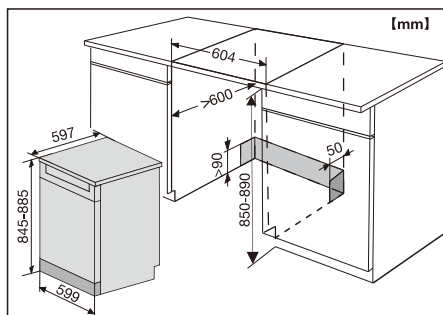

- When the dishwasher is installed in a recess without its worktop, the build-in measurements are shown in the illustration.

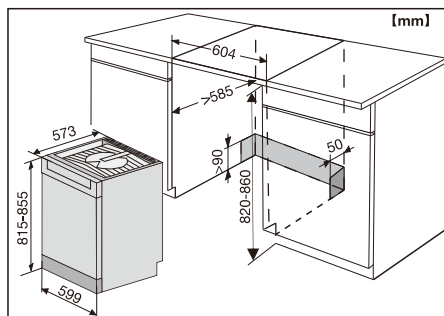

Adjust the height and slide the dishwasher into place

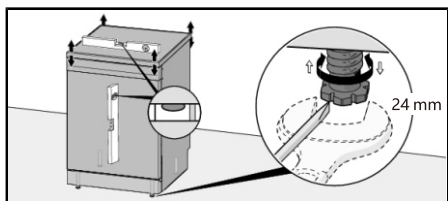

Freestanding

- Make sure the area on which the dishwasher is to be installed is firm. Adjust the dishwasher's height using the four feet so that the dishwasher is level. The dishwasher may lean no more than 5 mm.

Built-in

1. Start by measuring the height from the floor to the bottom edge of the worktop.
2. Measure the height from the floor to the top edge of the dishwasher.
3. Adjust the dishwasher's feet by turning them clockwise to raise or anticlockwise to lower the machine.
4. Check that there is an air gap of at least 3 mm between the underside of the worktop and the top edge of the dishwasher.
5. Slide the dishwasher into place.
 - Pull through the drainage and supply hoses when the machine is slid into place.
 - Check that the hoses have no kinks or sharp bends, and check that there is nothing that can damage the hoses.

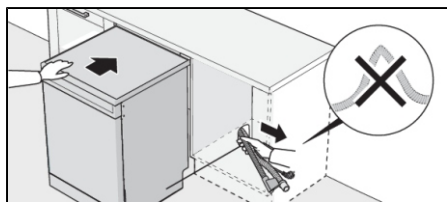

- Check that the machine is installed such that the door opens freely, otherwise door lock functionality may be disrupted.
6. Make any final adjustments to the front feet (the dishwasher may lean no more than 5 mm).
- The dishwasher can also be installed in a recess without its worktop. See *Remove dishwasher worktop*.

Check the dishwasher's fan outlet is not blocked or covered

The dishwasher's fan outlet is set in the gap between the door and plinth. In order to achieve better drying results by the dishwasher's fan dry, please check the dishwasher's fan outlet is not blocked or covered by debris or others when installing the dishwasher.

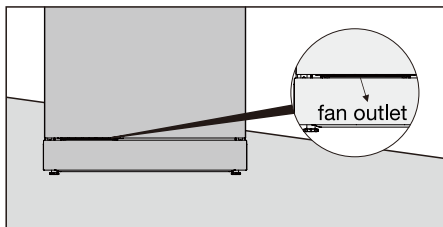

Drainage connection

This dishwasher is suitable for installing in a raised recess (to attain an ergonomic working height). This means that the dishwasher can be placed so that the drainage hose runs to a lower level than the bottom of the dishwasher, such as by routing it directly to a floor drain. The dishwasher is fitted with an integrated anti-siphon device to prevent the machine from being emptied of water during the wash cycle.

The drainage hose can also be connected to a connection nipple on the sink unit's water trap. The connection nipple must have an internal diameter of at least 14 mm.

The drainage hose may be extended by a maximum of 3 m (the total length of the drainage hose must not exceed 4.5 m). Any joins and connecting pipes must have an internal diameter of at least 14 mm. However, the drainage hose should ideally be replaced with a new hose without joins.

No part of the drainage hose may be more than 950 mm above the bottom of the dishwasher.

Attach the drainage hose with a hose clamp. Ensure that the drainage hose has no kinks.

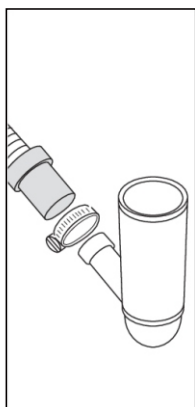
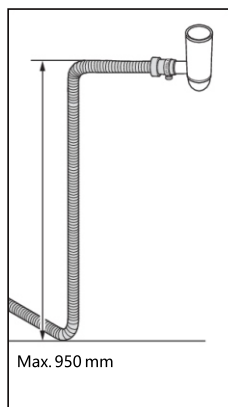
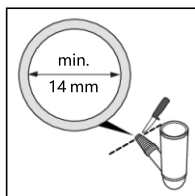
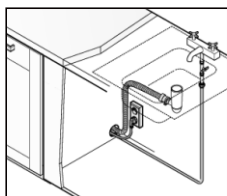

Connection to water supply

Use only the inlet hose supplied with the dishwasher. Do not re-use old or other spare hoses.

The supply pipe must be fitted with a water tap (stopcock). The water tap must be easily accessible, so that the water can be shut off if the dishwasher has to be moved.

Once the installation is complete, turn on the water tap and allow the pressure to settle for a while. Check that all connections are watertight.



NOTE!

New hose-sets supplied with the appliance are to be used and that old hose-sets should not be reused.

Connection to cold water supply

Connect the dishwasher to the cold water supply if the building is heated using oil, electricity or gas.

Connection to hot water supply

Connect the dishwasher to the hot water supply (max. 60 °C) if the building is heated using an energy-efficient means such as district heating, solar power or geothermal power. Choosing a hot water connection reduces the dishwasher's energy consumption.



NOTE!

Do not exceed the permitted water supply temperature. Certain materials used in some cookware cannot withstand high heat. See *Fragile dishes* in the chapter *Loading the dishwasher*.

Electrical connection

Information about the electrical connection can be found on the serial number plate. This specification must match the electricity supply.

The dishwasher must be connected to an earthed socket.

The electric wall socket must be placed outside of the installation area to be easily accessible after installing the dishwasher. Do not use an extension cord!

Remove dishwasher worktop

The dishwasher can be installed in a recess without its worktop. If the dishwasher's worktop is removed, the dishwasher must be installed under a separate worktop.

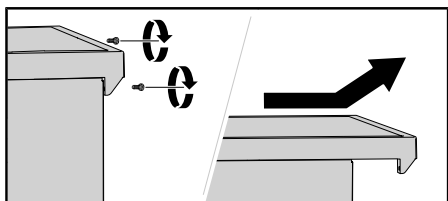

Service

Read the chapter *Troubleshooting* before contacting the service centre. If you have encountered a problem that you cannot resolve, please contact your nearest service centre for professional help, see www.hisense.com.au. Our website also has information about spare part availability and what you can repair yourself.

When making contact, provide the details on the serial number plate. Include the model number. Please note that non-professional repairs may risk user safety and affect the warranty.

Technical data and energy labelling

Information on energy label

Australian standard:	AS/NZS 2007
Number of place settings:	16
Dishwashing program:	Eco ¹⁾
Program time:	3:40 hours:minutes
Connection:	Cold water 20 °C
Test method for noise measurement:	IEC 60704-2-3

¹⁾ The program Eco is recommended for a normally soiled load equal to the rated capacity of the dishwasher.

Technical data

Height:	845-885mm
Width:	599 mm
Depth:	597 mm
Weight:	44.9kg ¹⁾
Water pressure:	0.03-1.0 MPa
Rated voltage:	220-240 V~ 50 Hz
Rated power:	1900 W

¹⁾ Weight can vary due to different specifications.

Information for consumers

Information about your product can be found at <https://hisense.com.au>. Please click on the magnifying glass icon and type the Model Number in the search bar.

Test standard

Dishwasher tested in conformity with standard AS/NZS 2007.1 2021

Capacity: 16 place settings

Upper basket in lower position

Program: Eco

Cutlery used: Alternative cutlery acc to GEMS Determination 2015, § 7 (3) (d), specified in schedule 1, part 4

1. Upper basket:

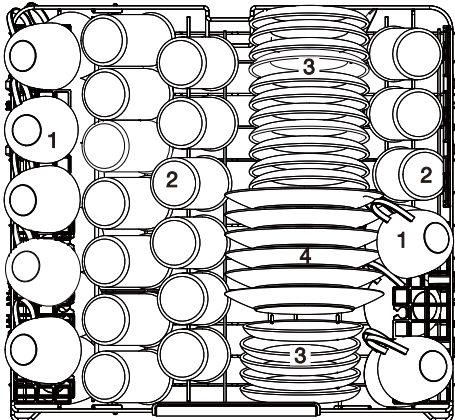

Number	Item
1	Cup
2	Glass
3	Saucer
4	Bread-and-butter plate

2. Lower basket:

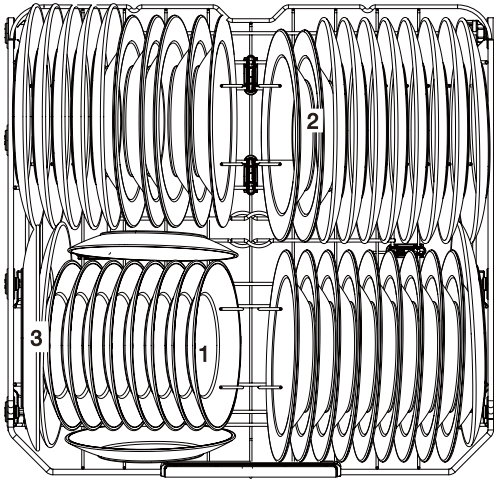

Number	Item
1	Bread-and-butter plate
2	Dinner plate
3	Soup(Dessert) plate

3. Top cutlery tray:

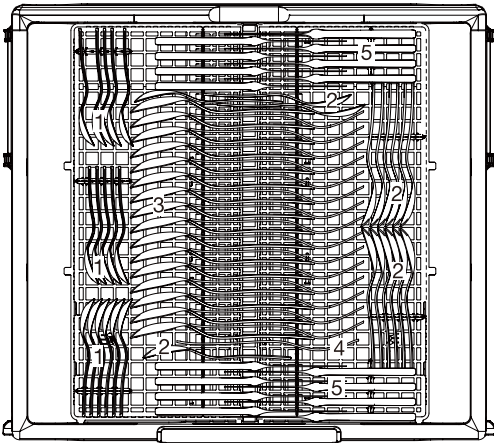

Number	Item
1	Tea spoon
2	Dessert spoon
3	Soup spoon
4	Fork
5	Knife

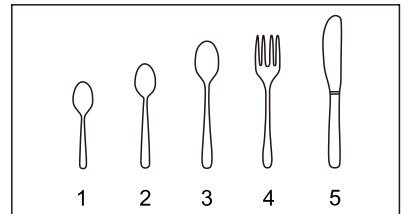

Hisense